

1

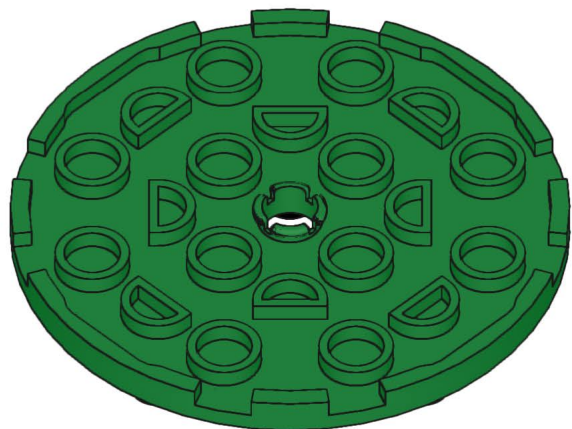

2

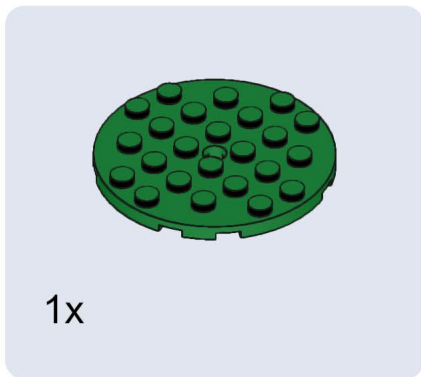
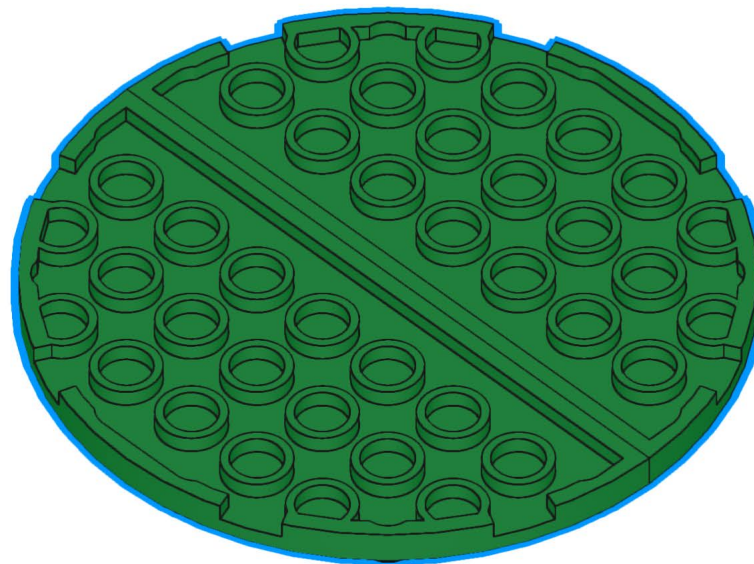
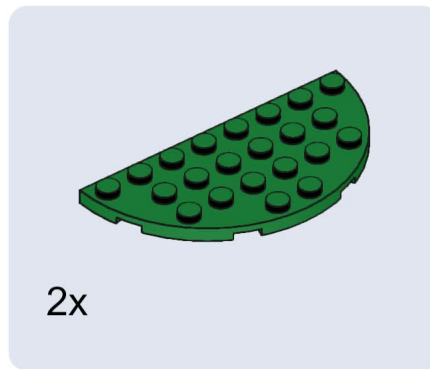

3



4x



1x

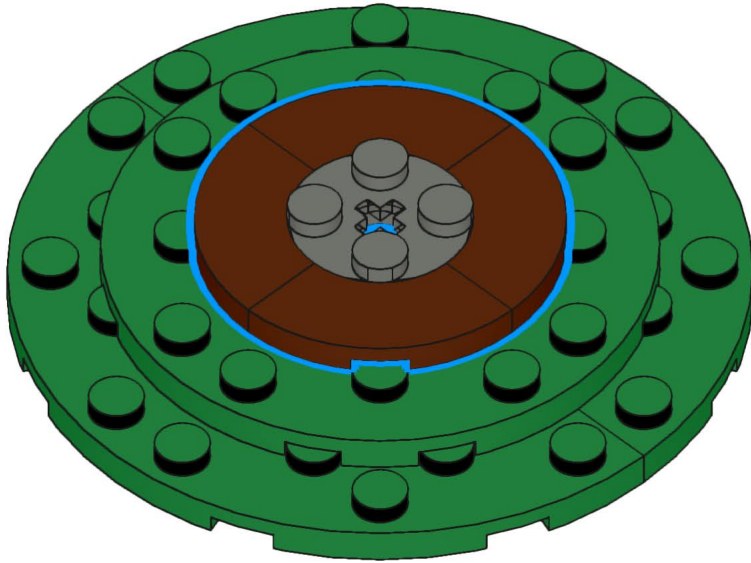

4



1x

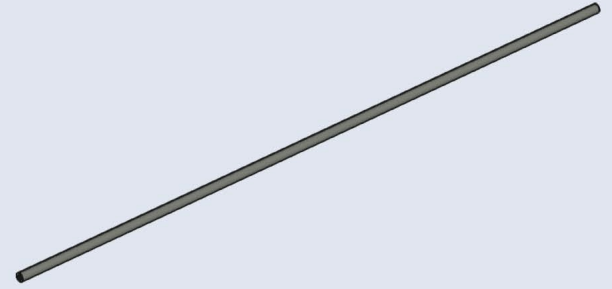

1x

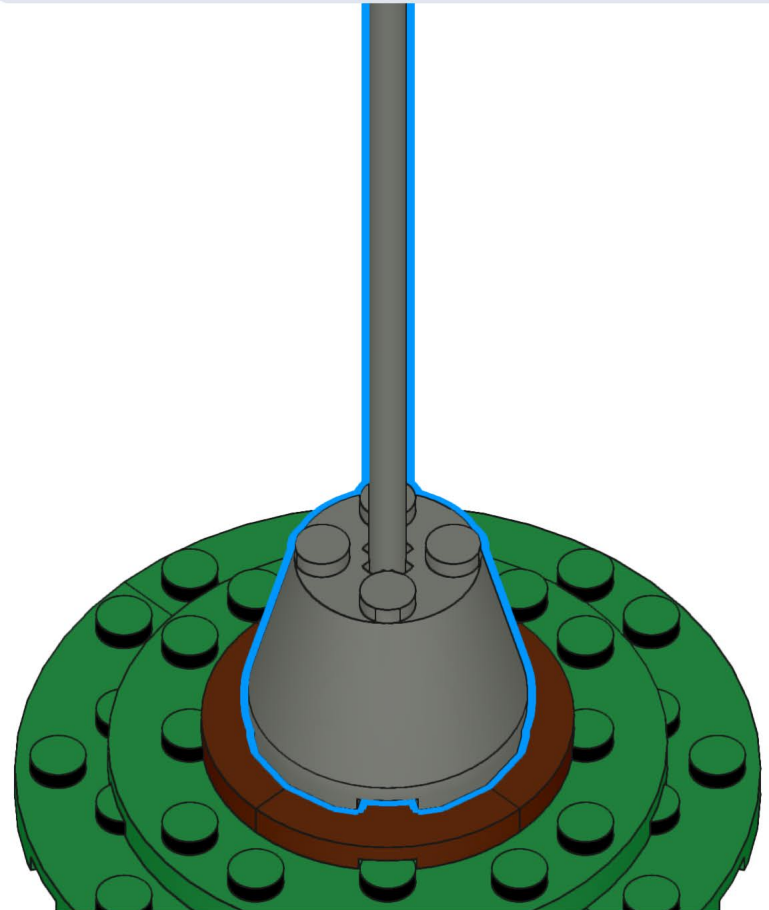

5

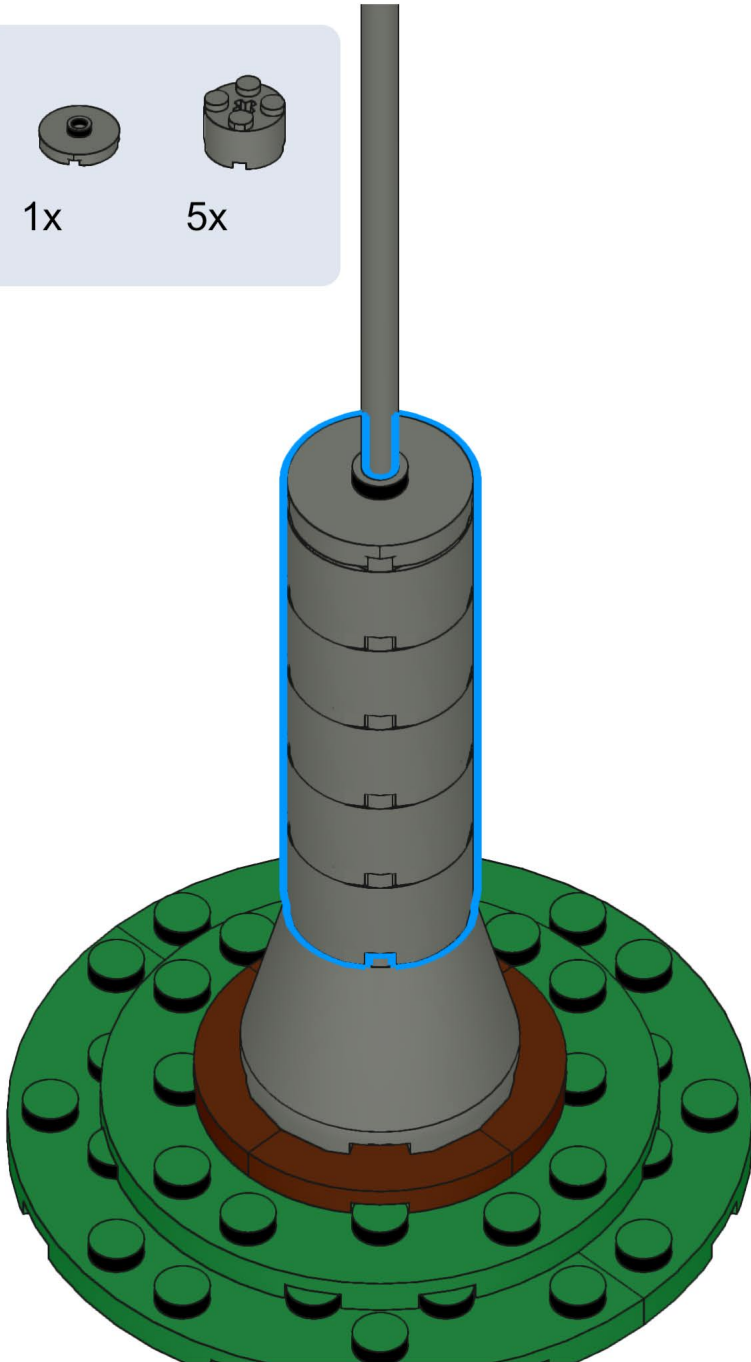
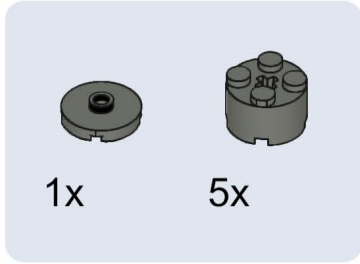

6

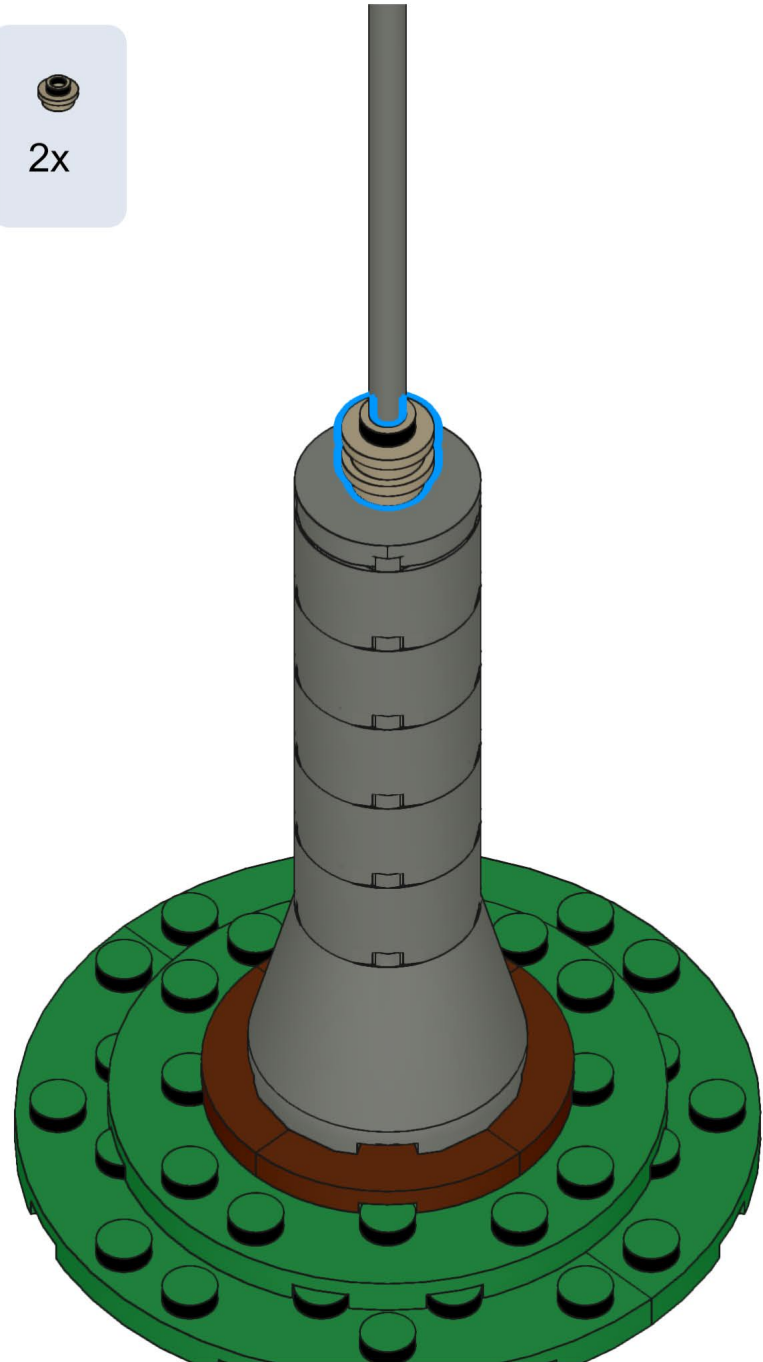

7



1x

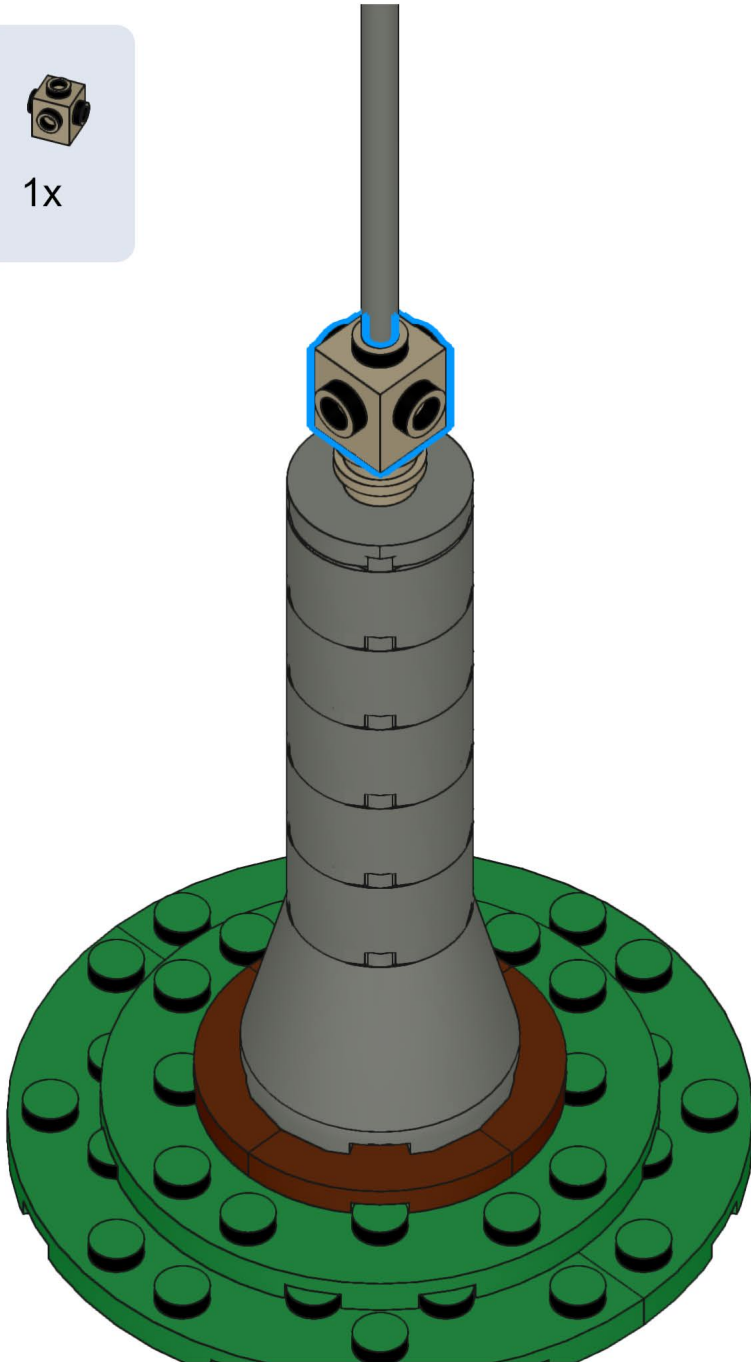

8



2x

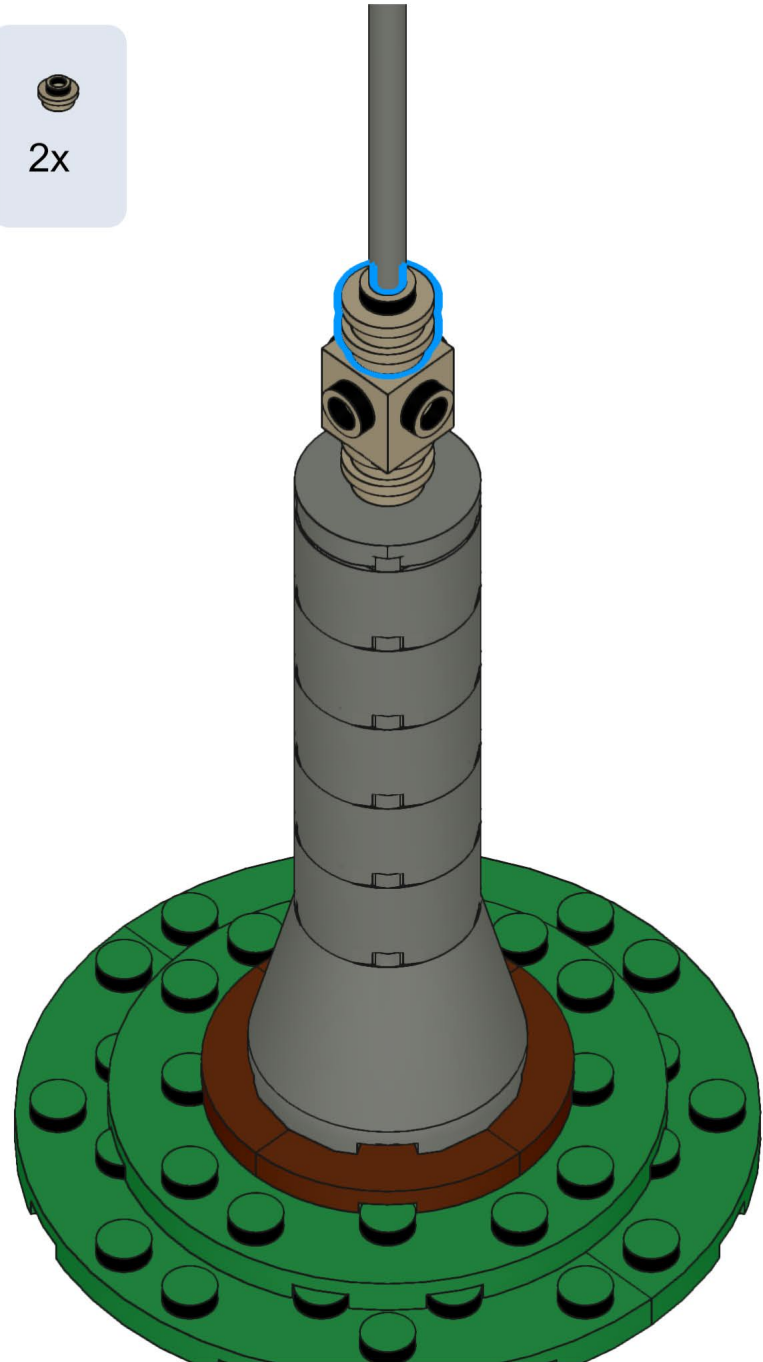

9



1x

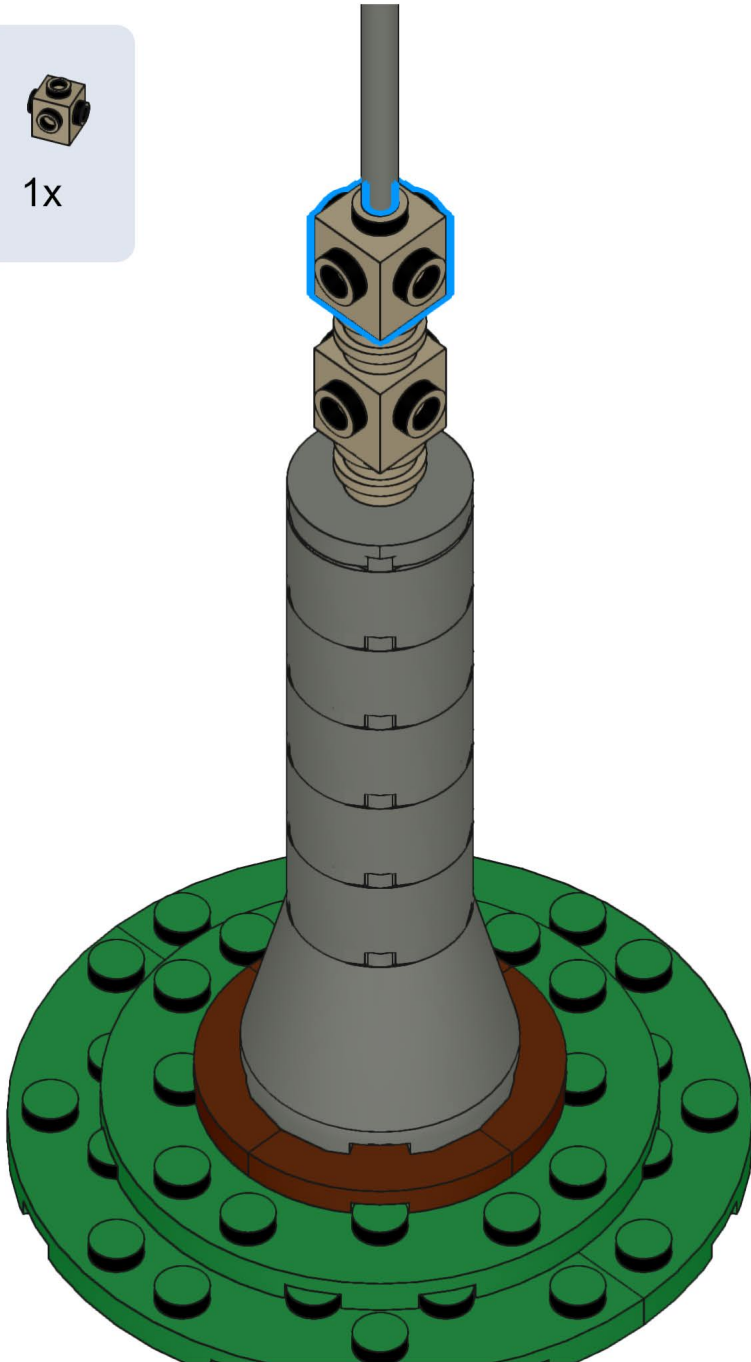

10



4x



4x

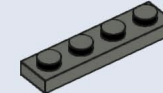

4x

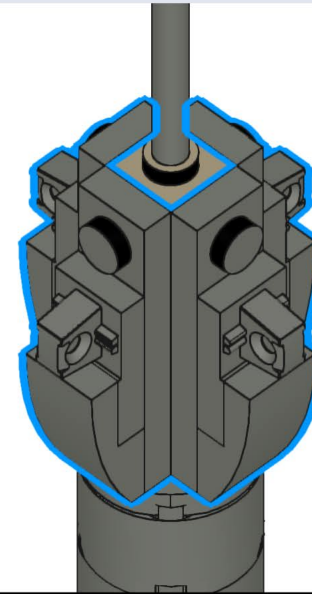

1

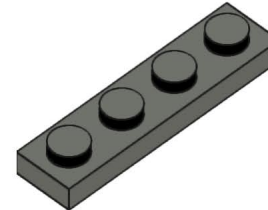

4x

2

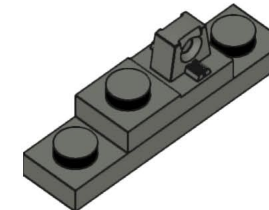

3

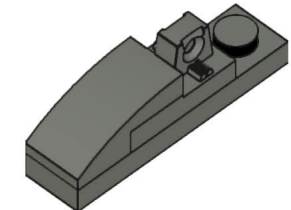

# 11



2x

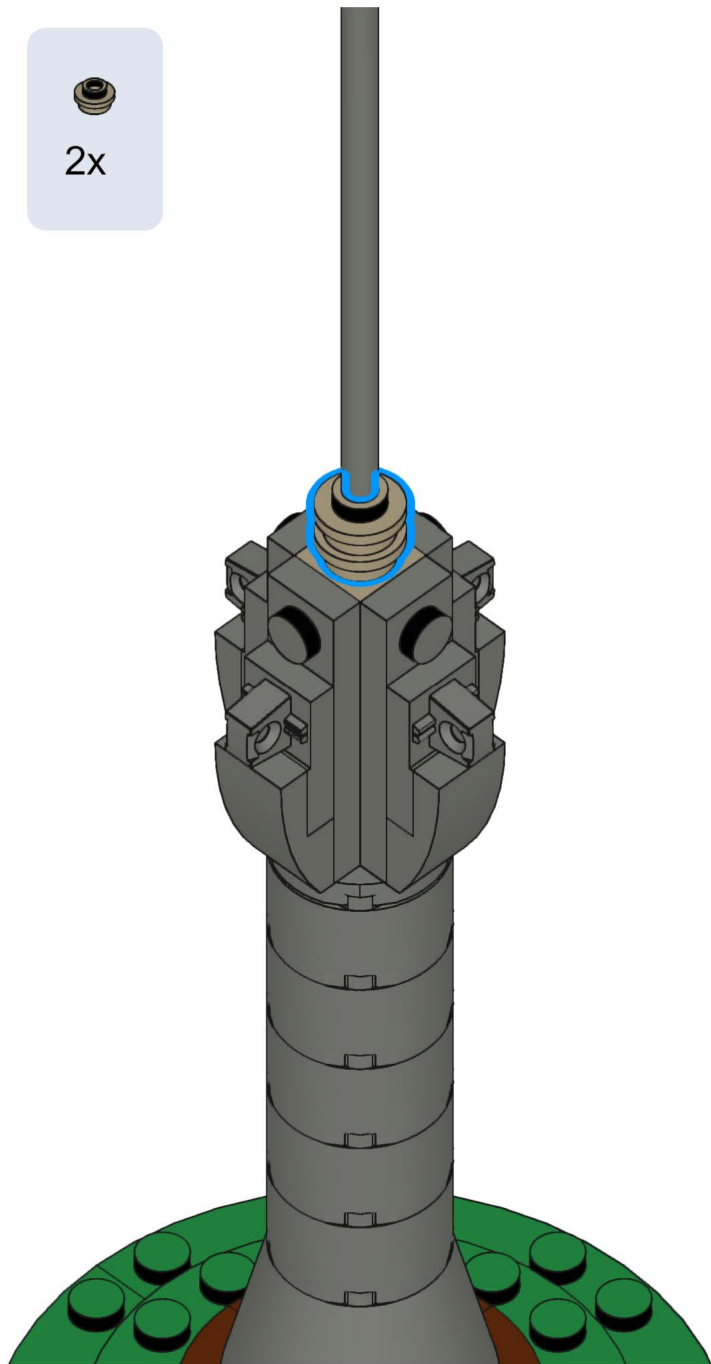

# 12



1x

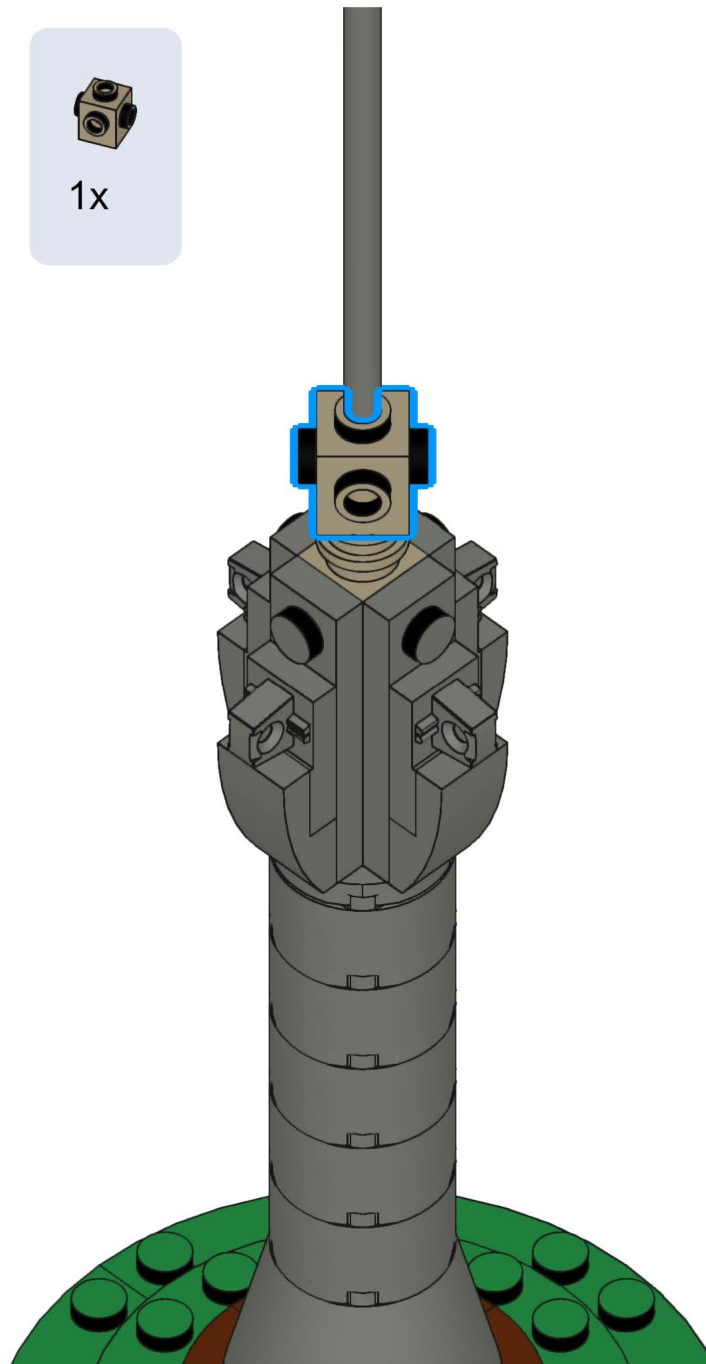

13



2x

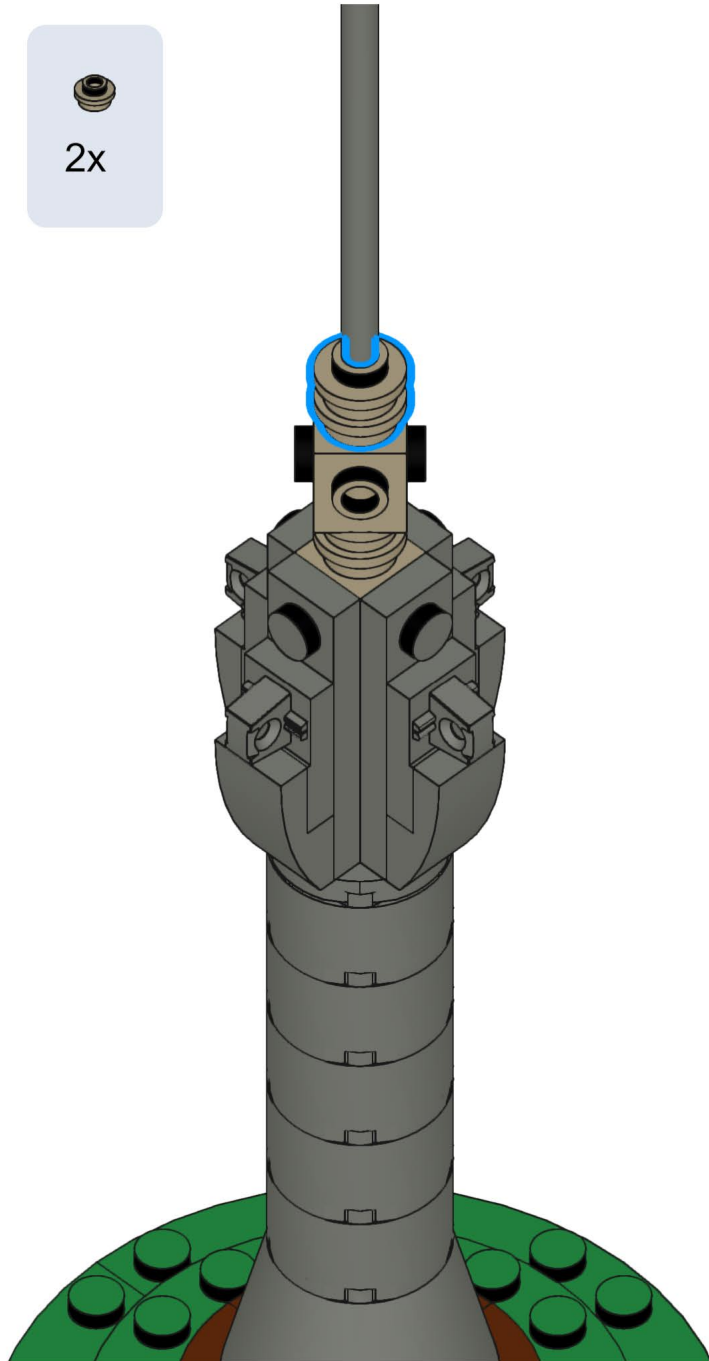

14



1x

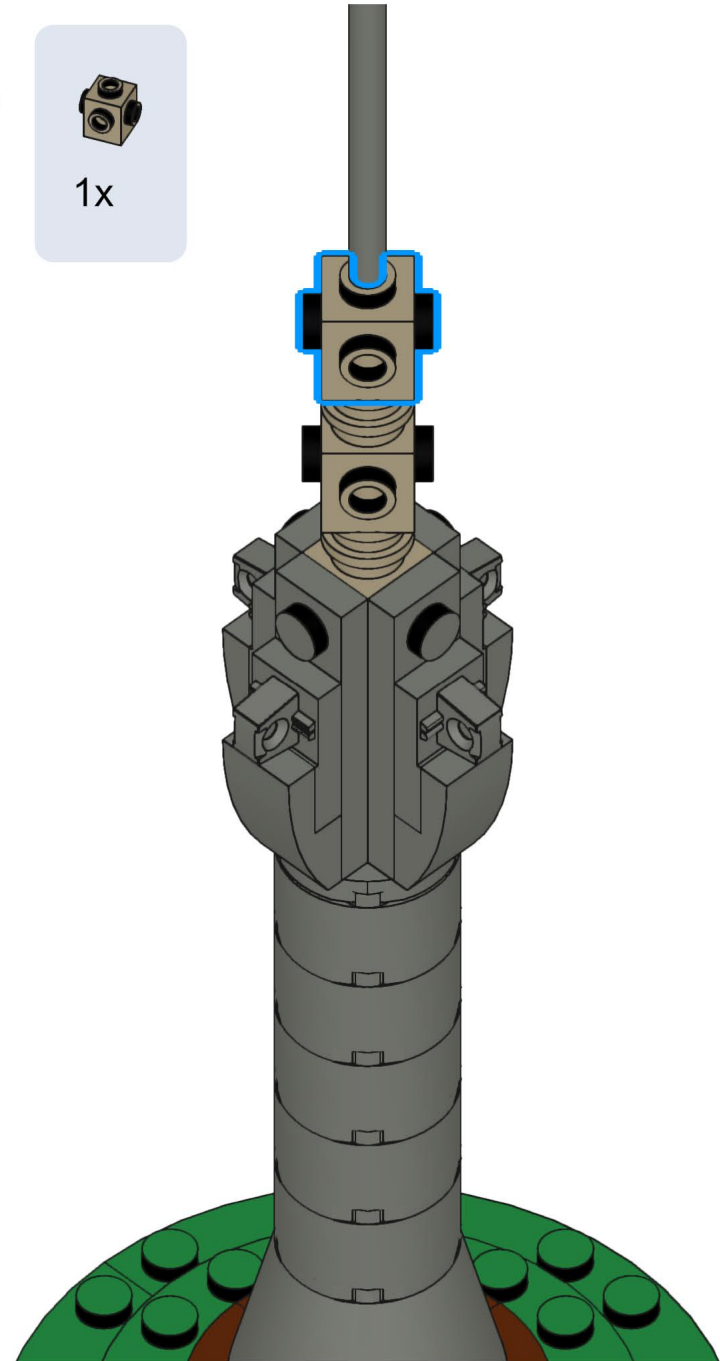

# 15

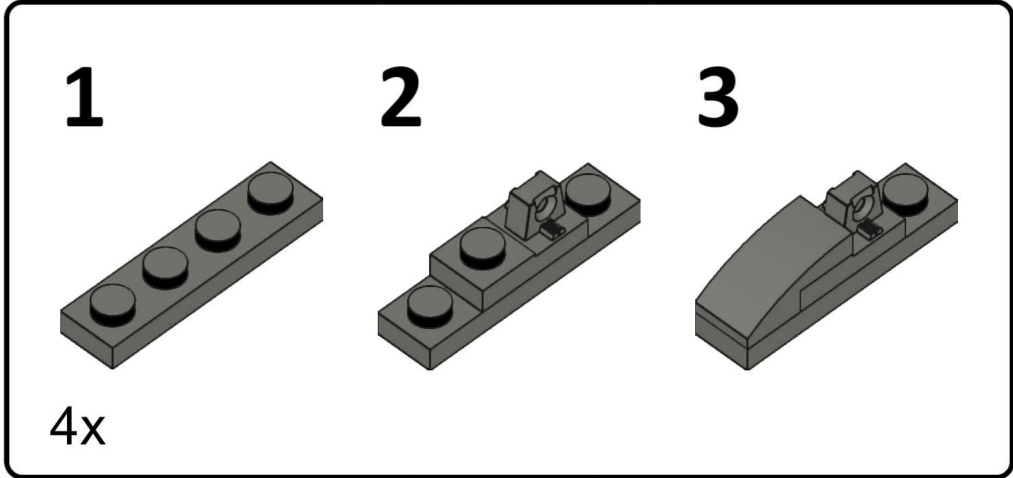
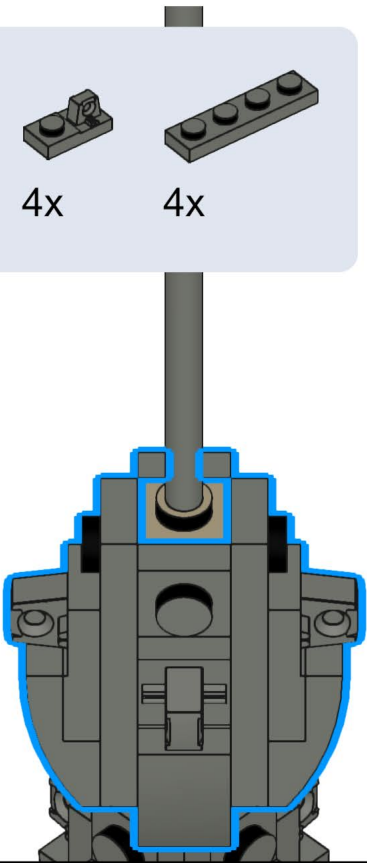
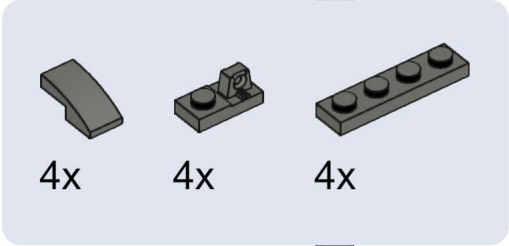

# 16

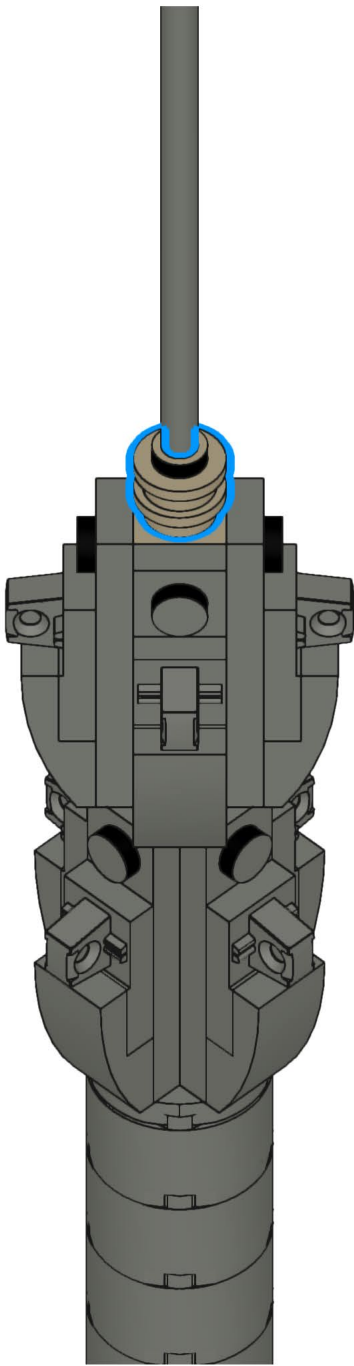



# 17



1x

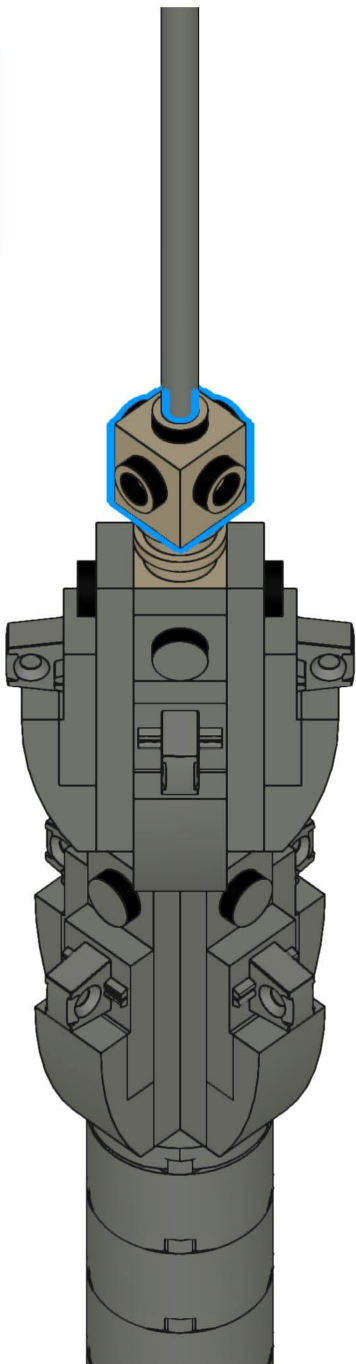

# 18



2x

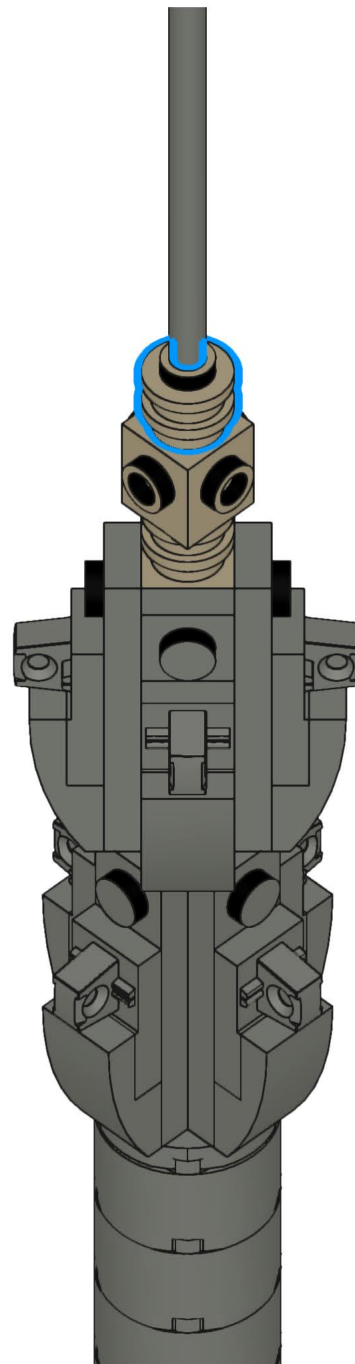

# 19



1x

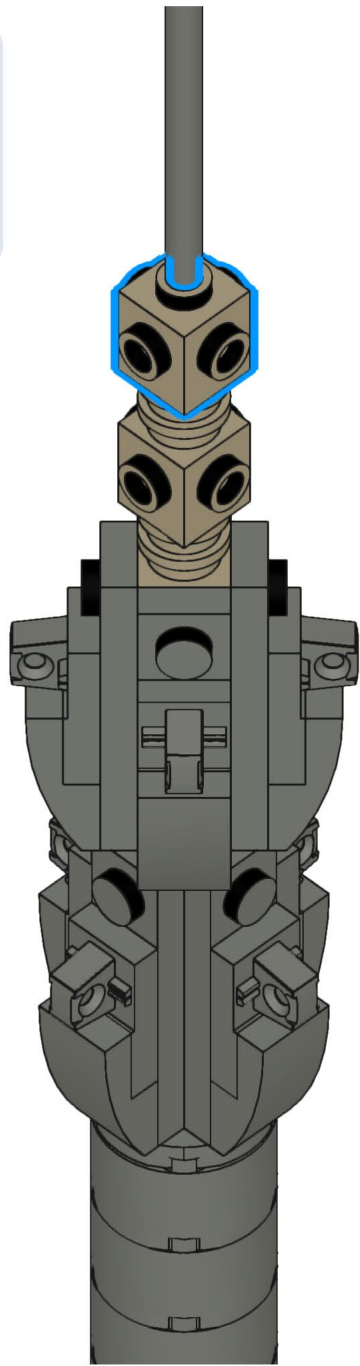

# 20

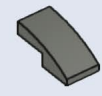

4x

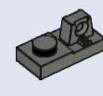

4x

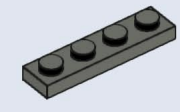

4x

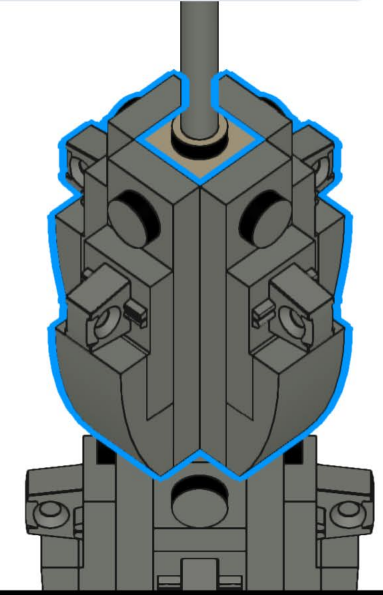

## 1

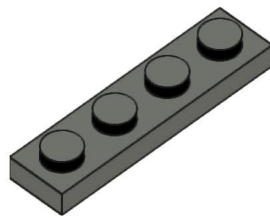

4x

## 2

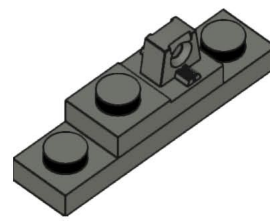

## 3

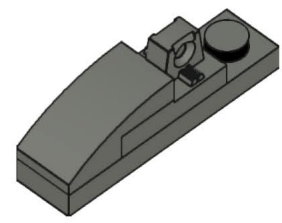

# 21



1x

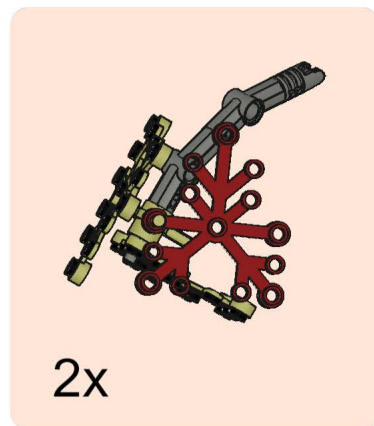

2x

# 22



1x

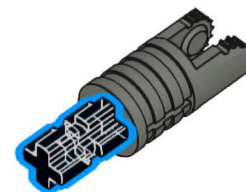

# 23

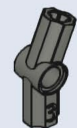

1x

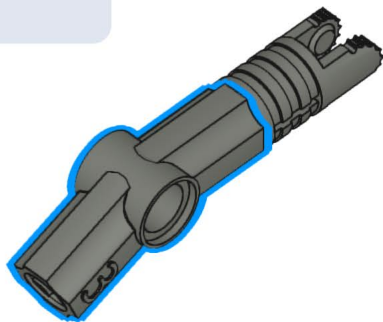

# 24



1x

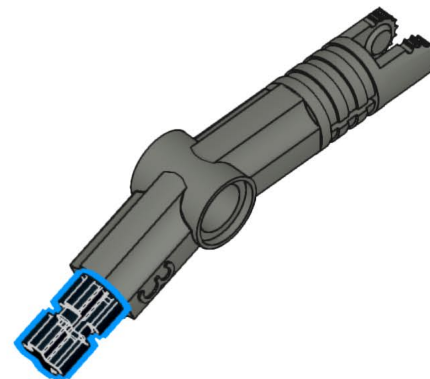

25



1x

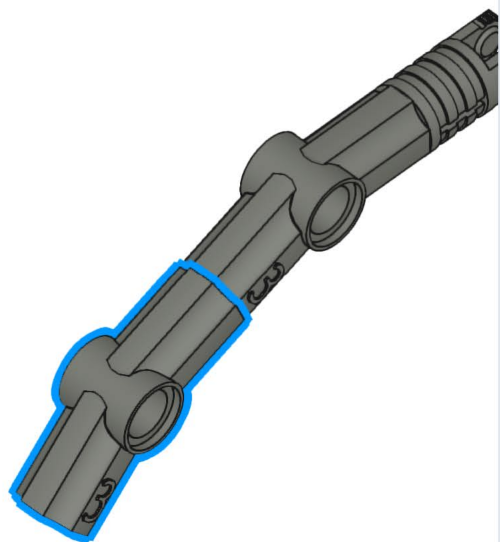

26



1x

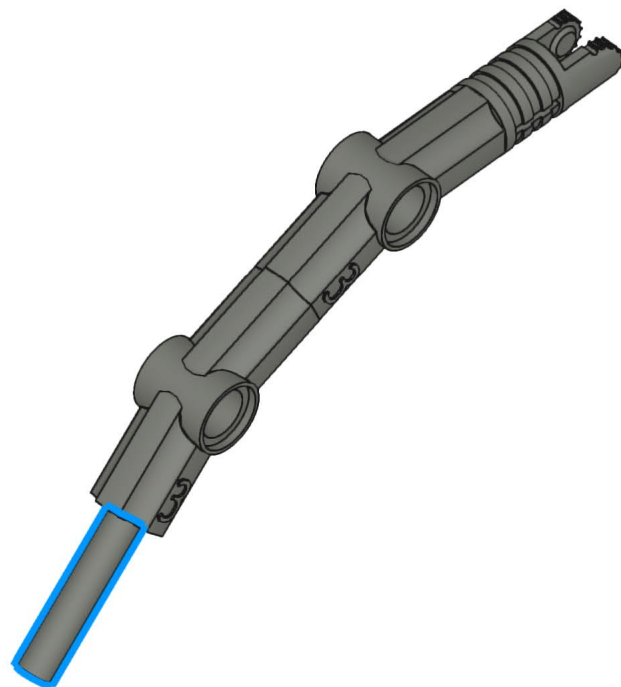

27



1x

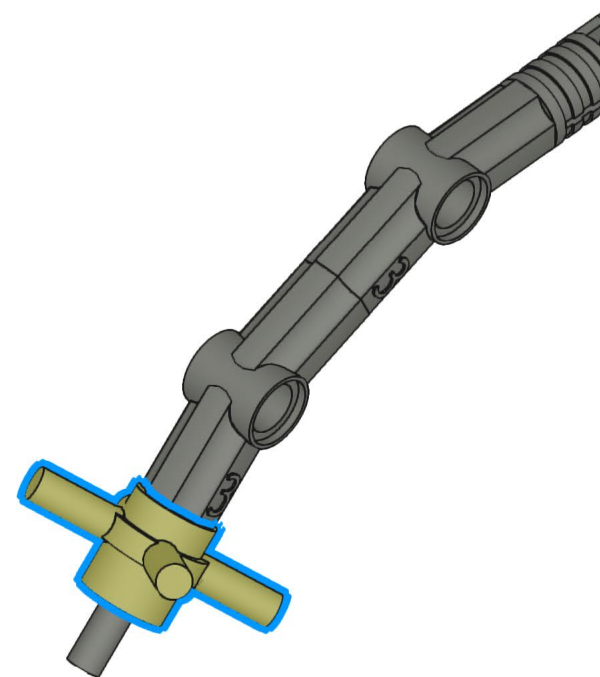

# 28

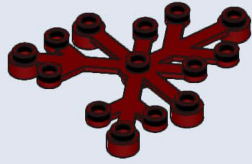

1x

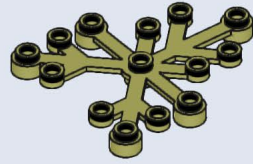

2x

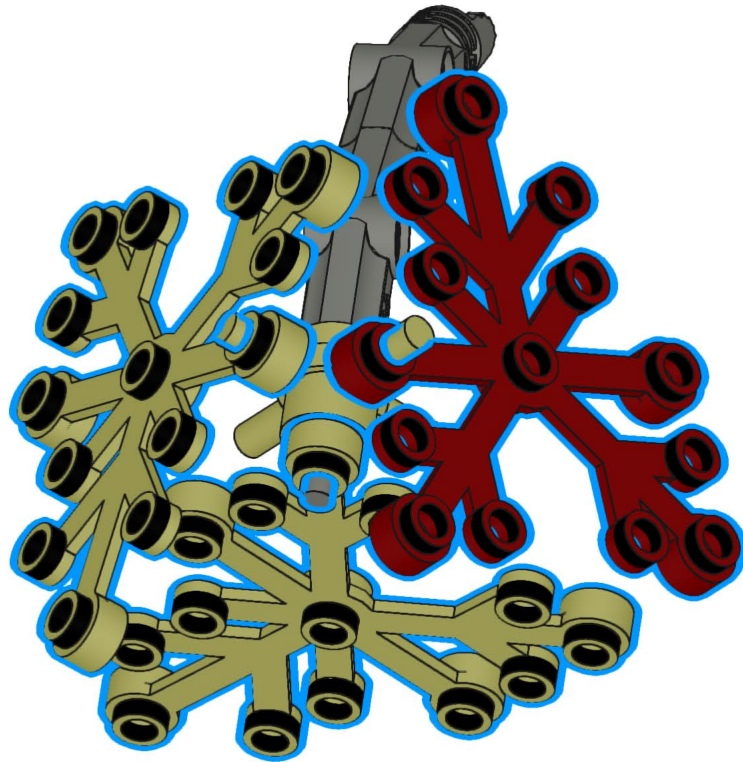

# 29

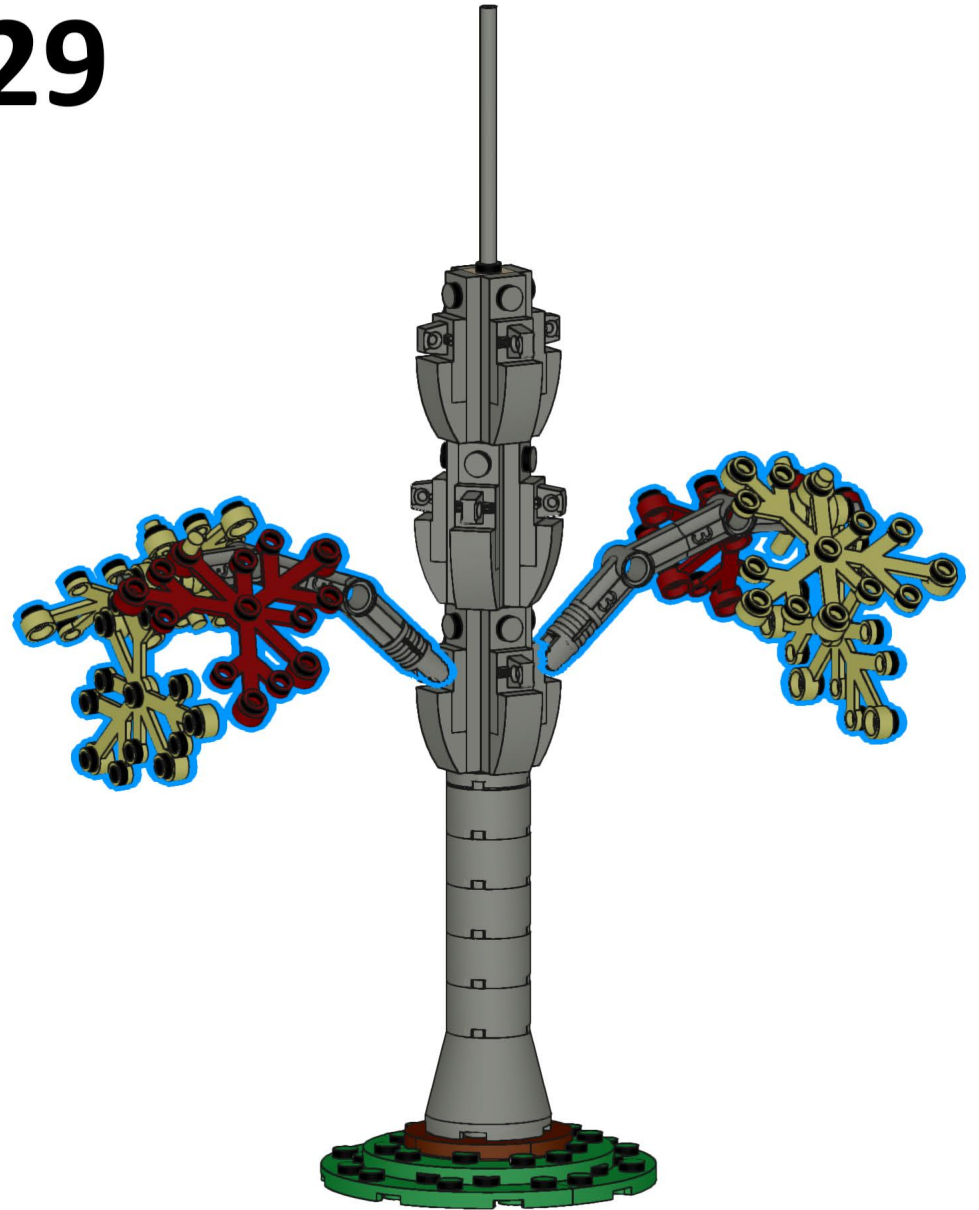

# 30



1x

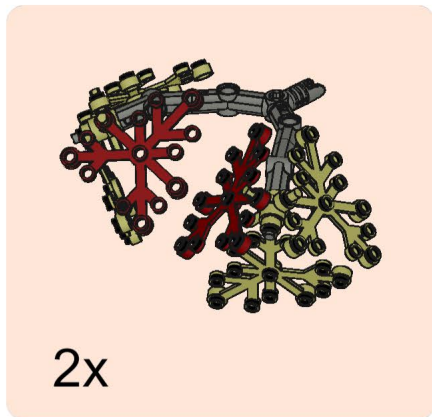

2x

# 31



1x

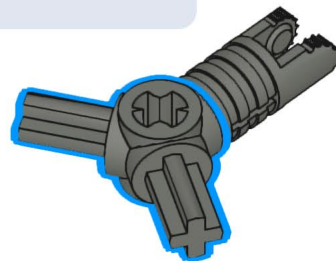

# 32



2x

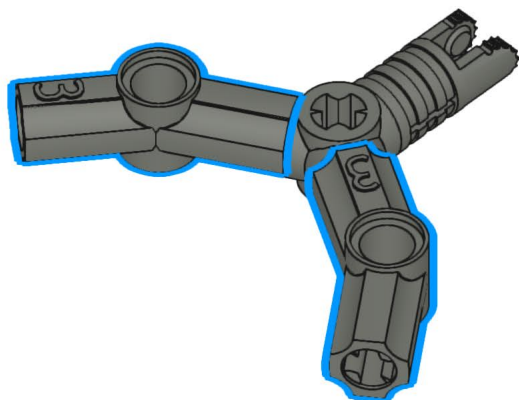

# 33



2x

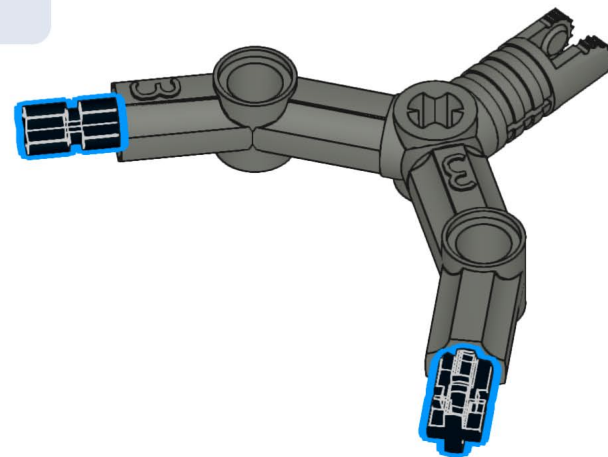

# 34



2x

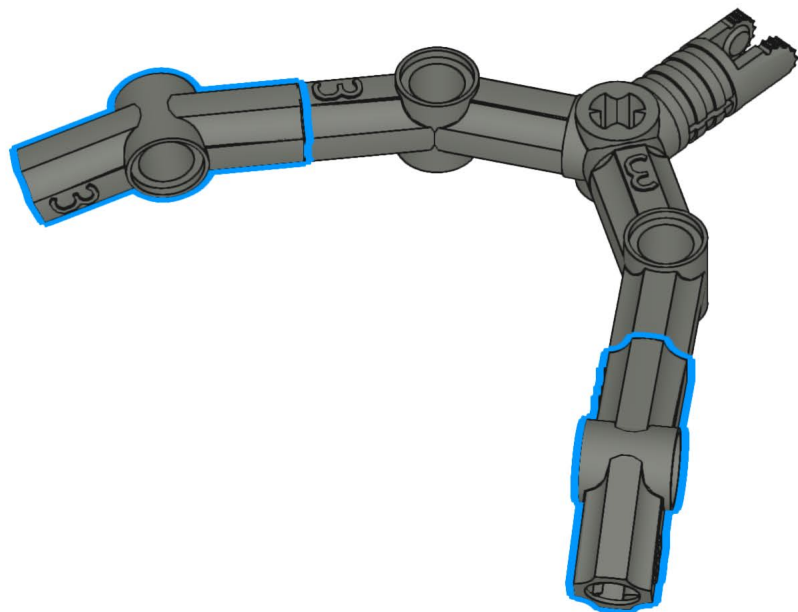

# 35



2x



2x

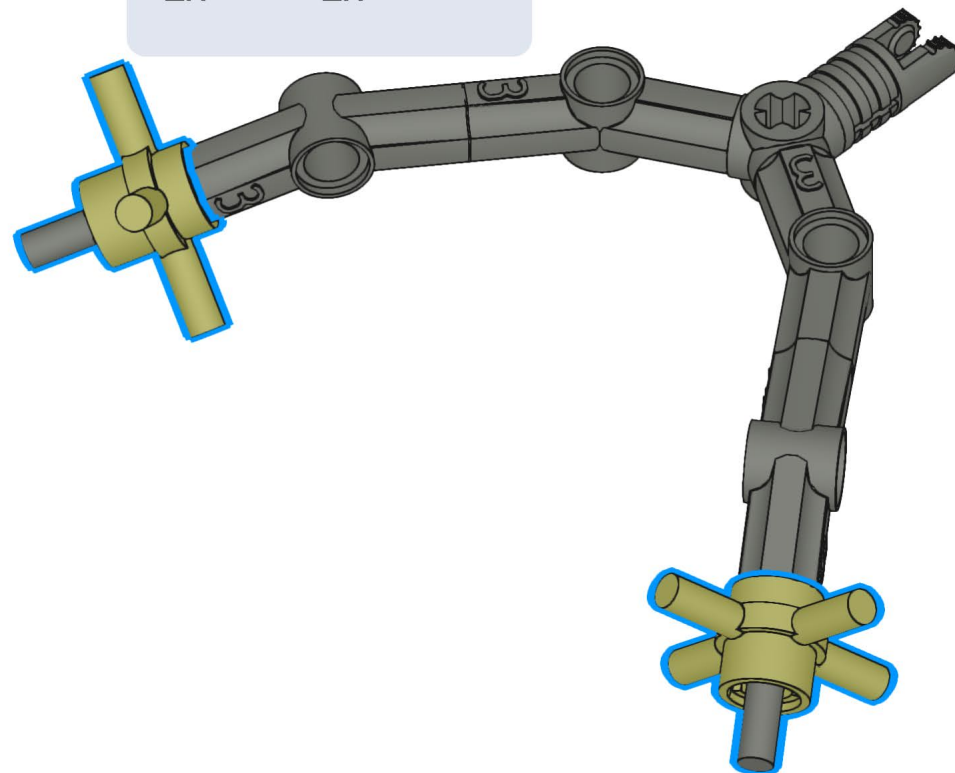

# 36

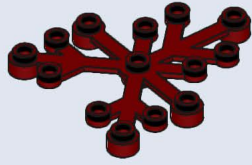

2x

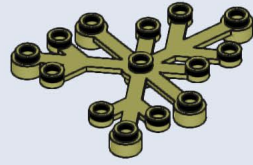

2x

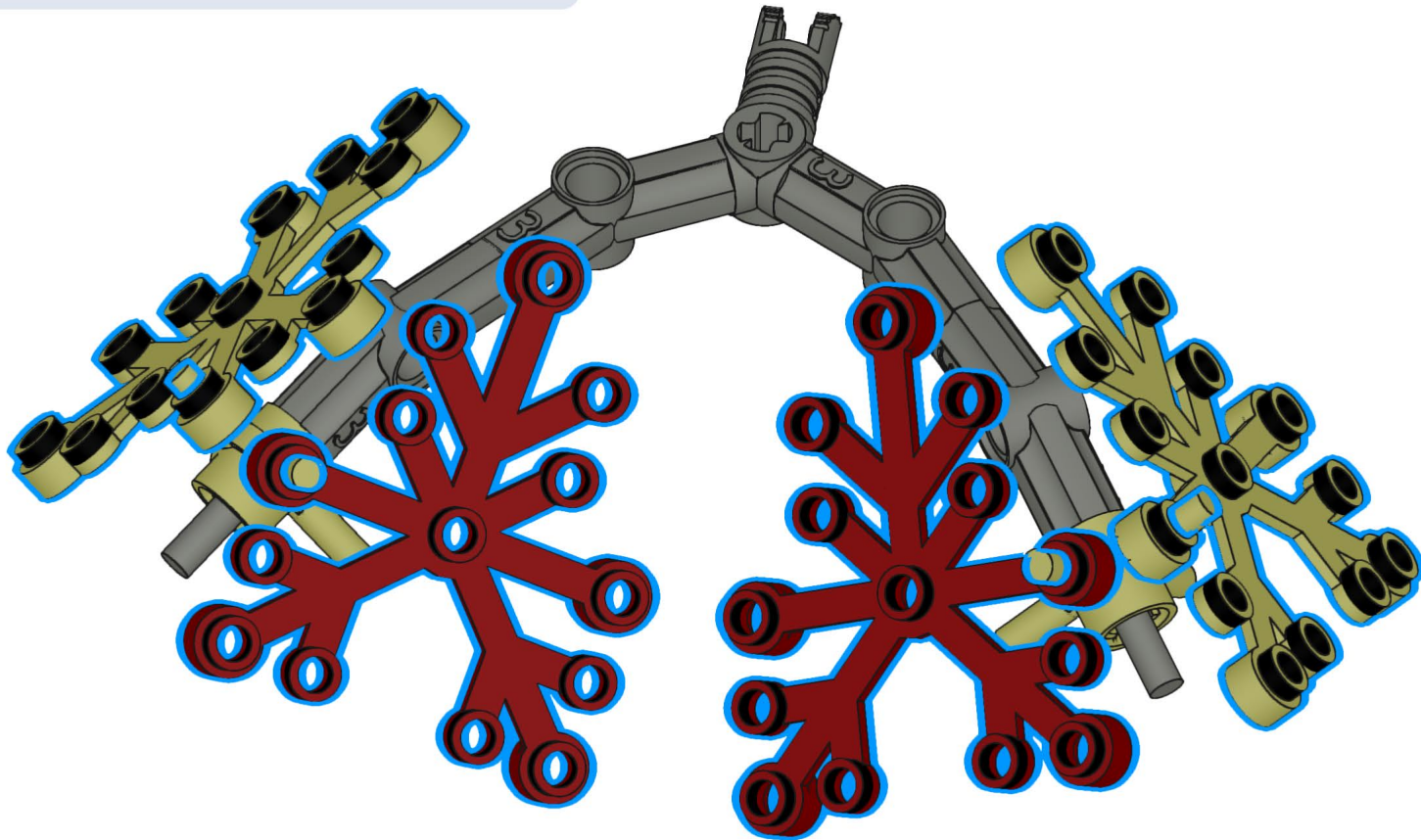



37

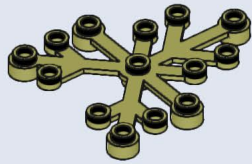

2x

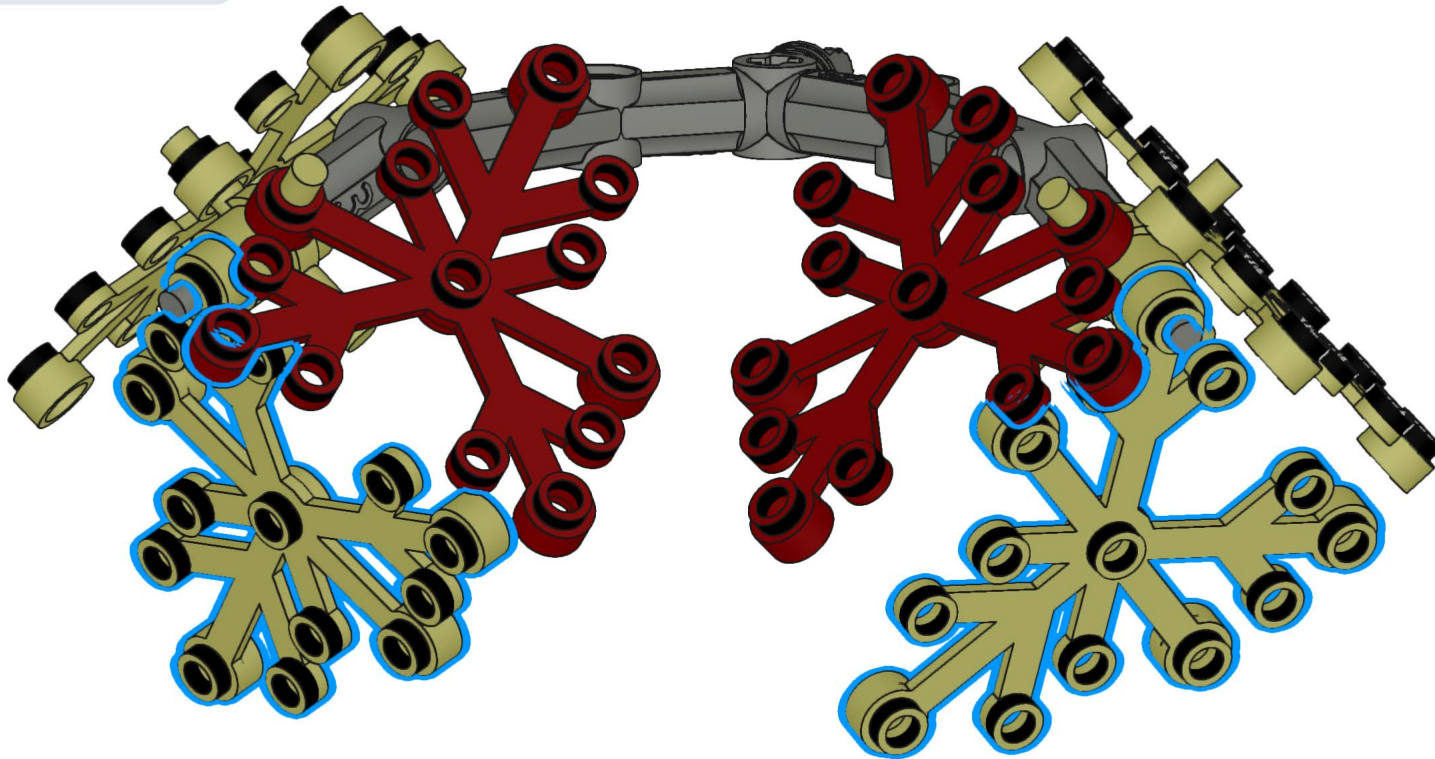

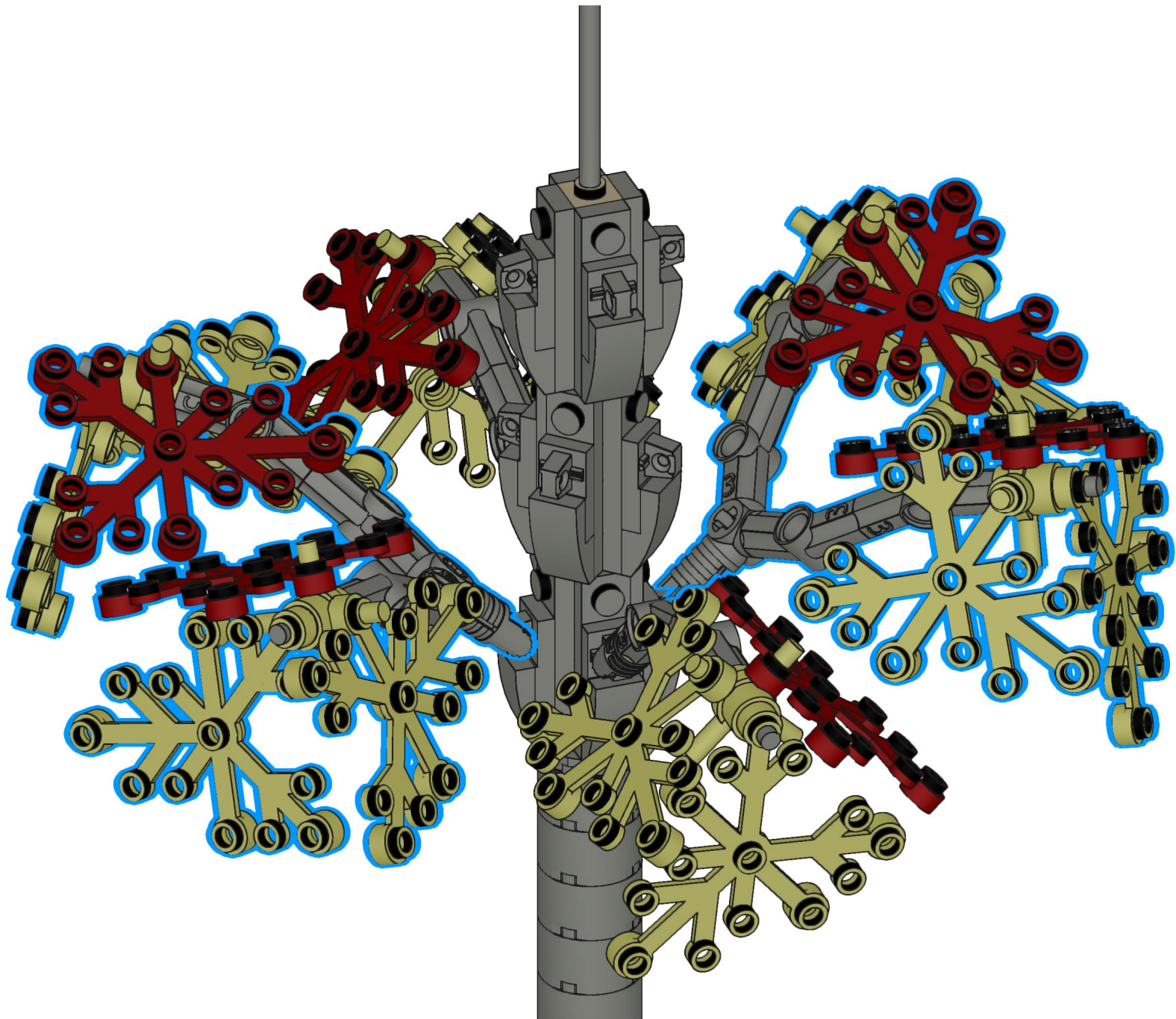

# 39



1x



4x

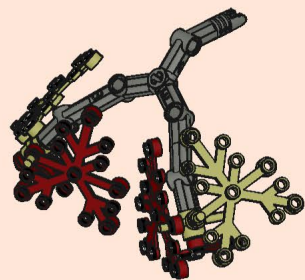

# 40



1x

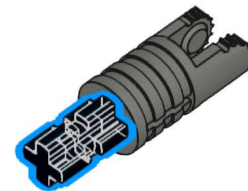

# 41



1x

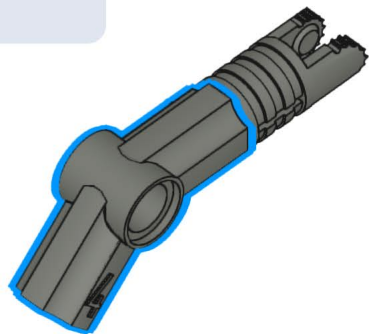

# 42



1x

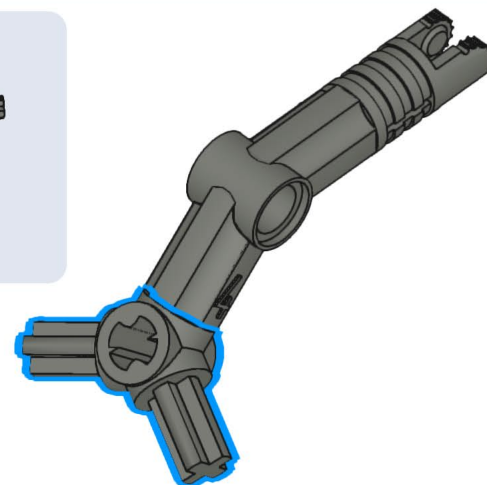

43



2x

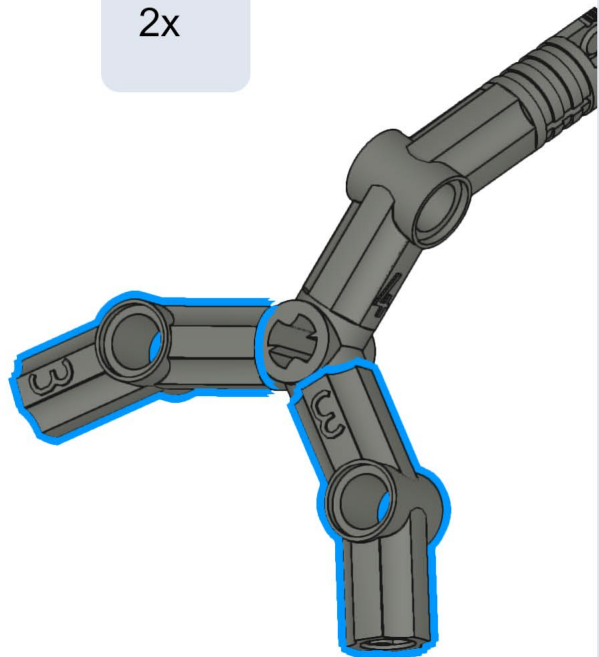

44



2x

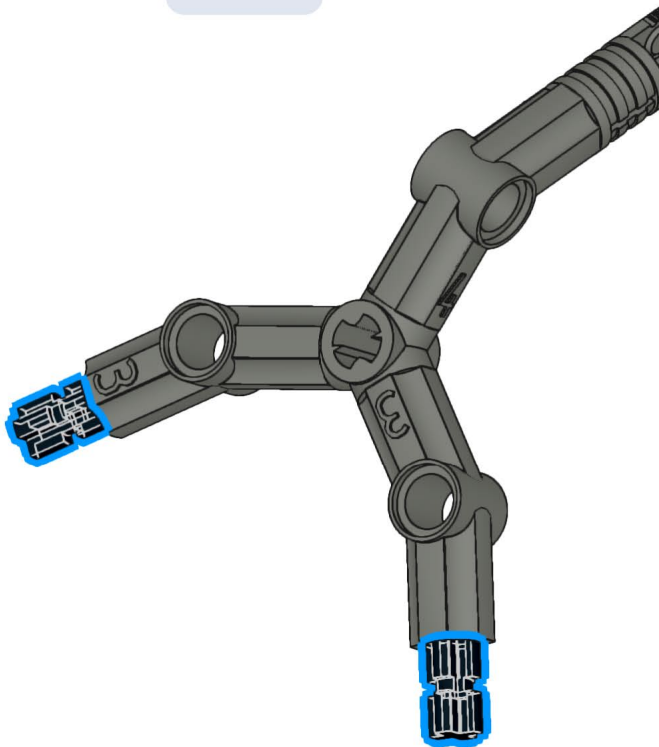

45



2x

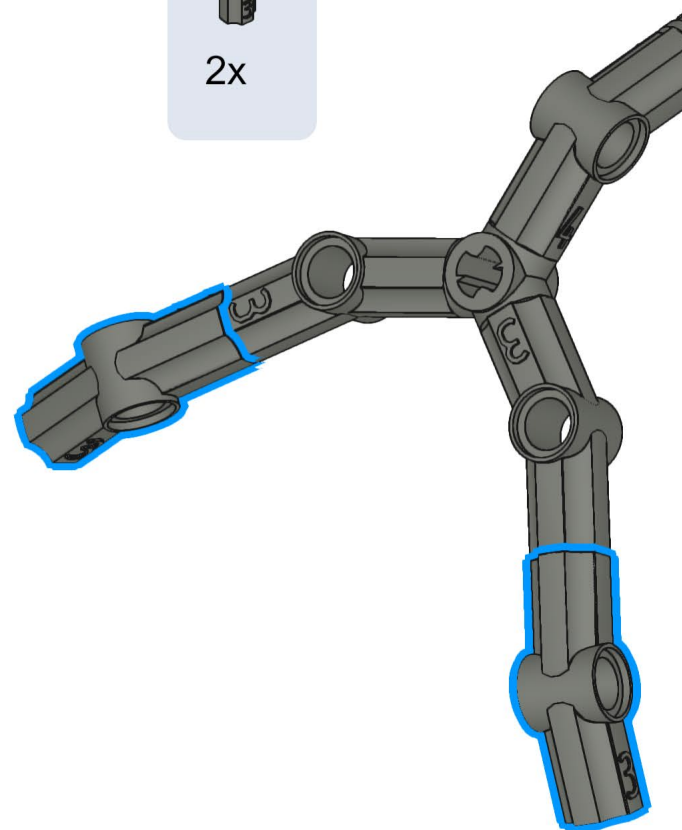

46

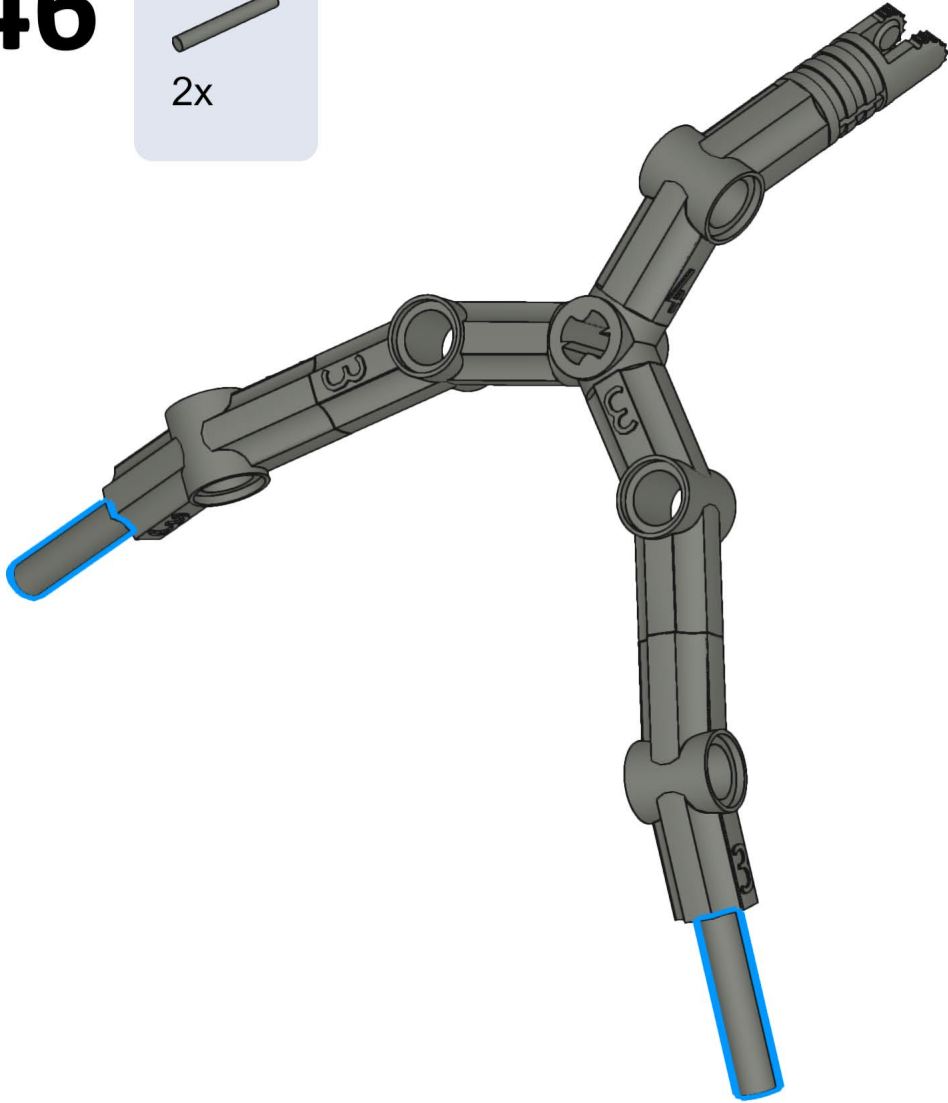
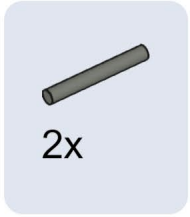

47

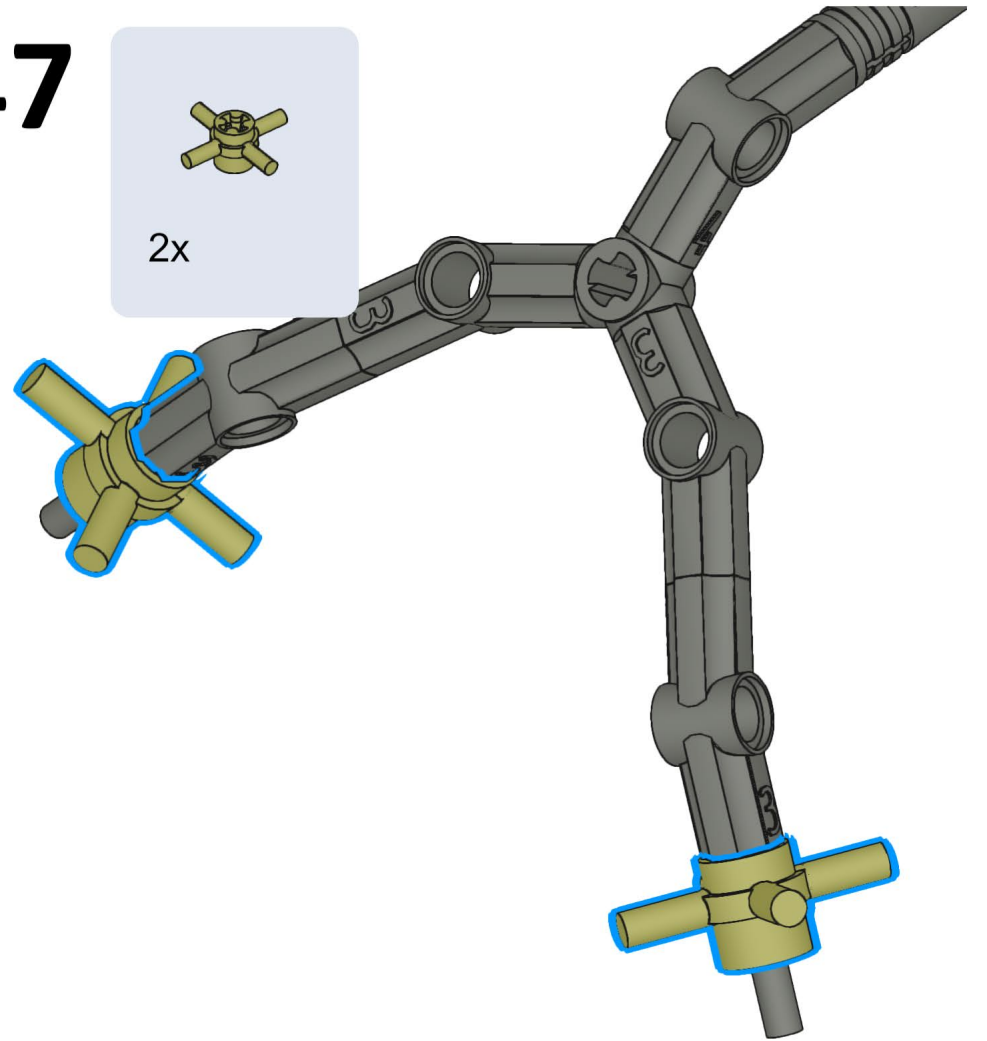
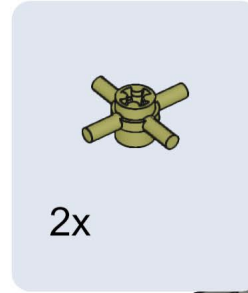

48

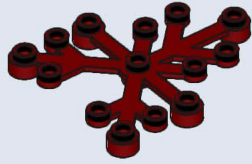

2x

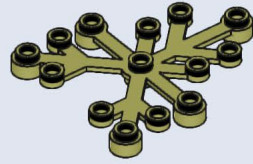

2x

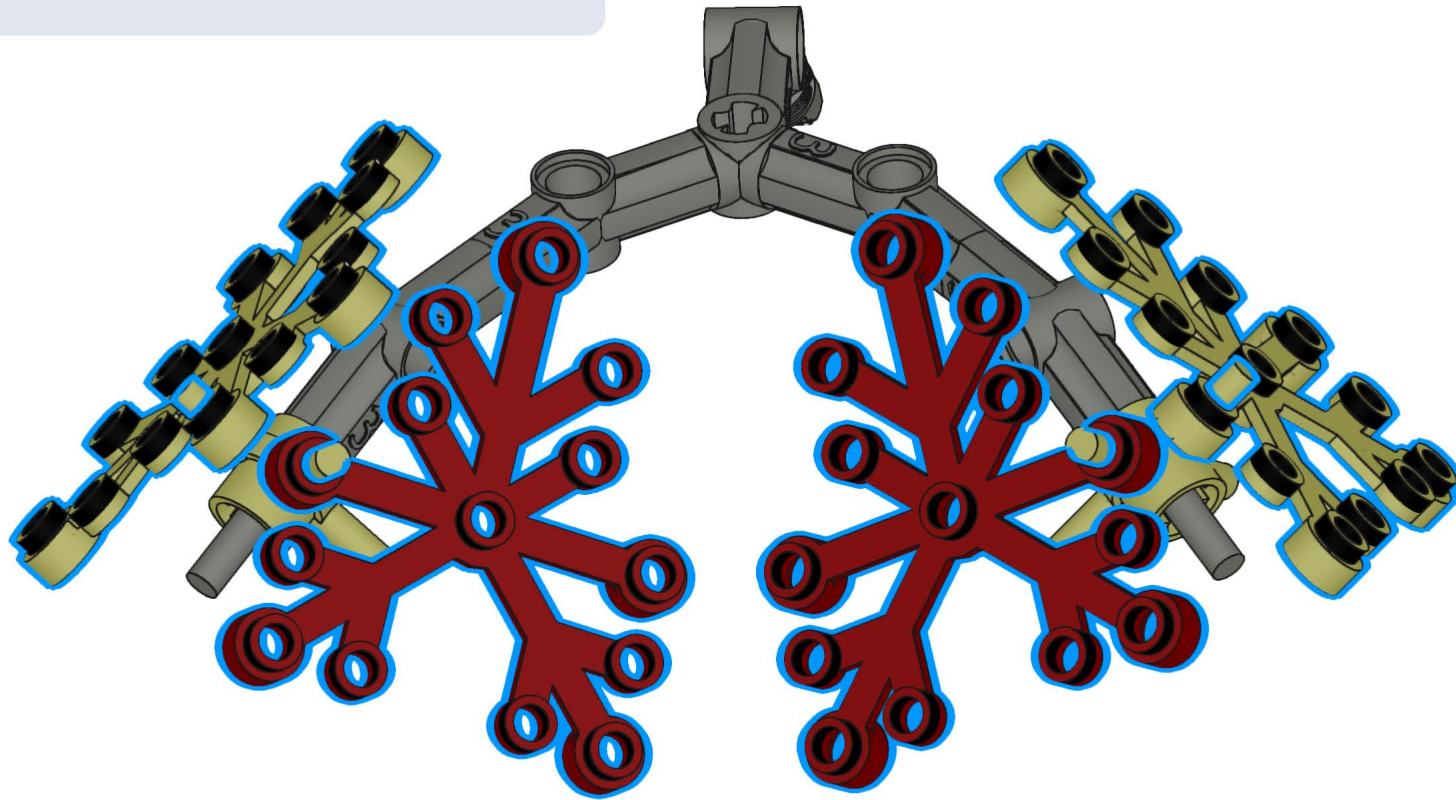

49



2x

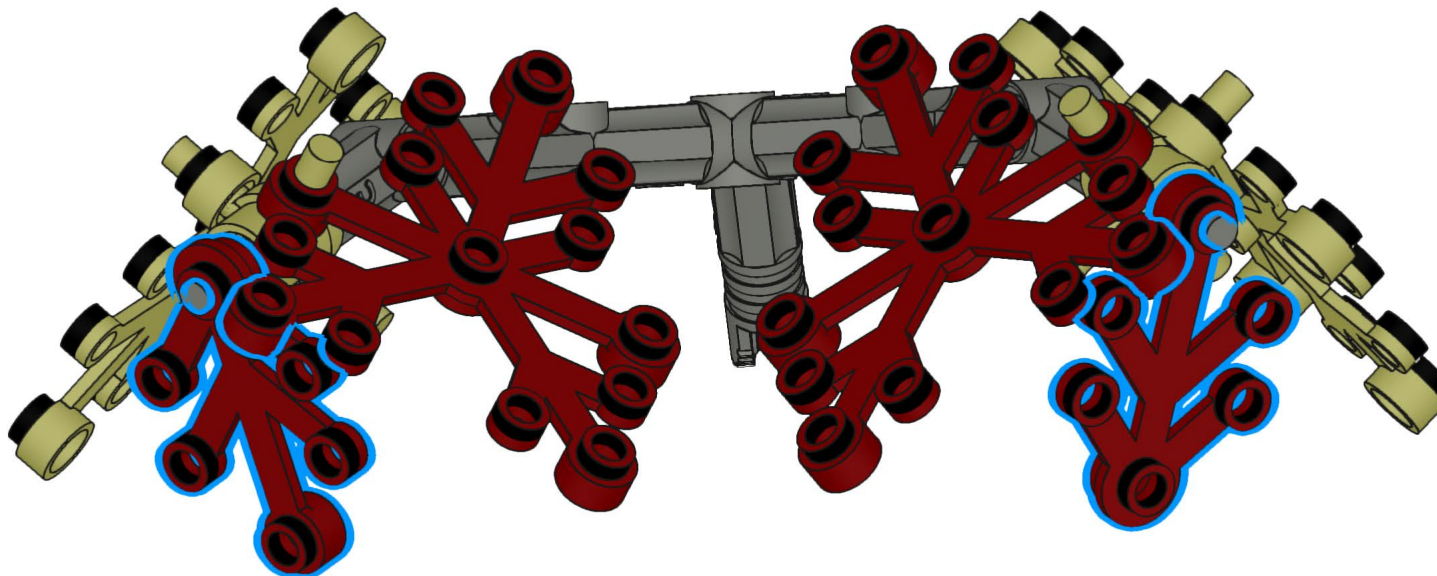

50

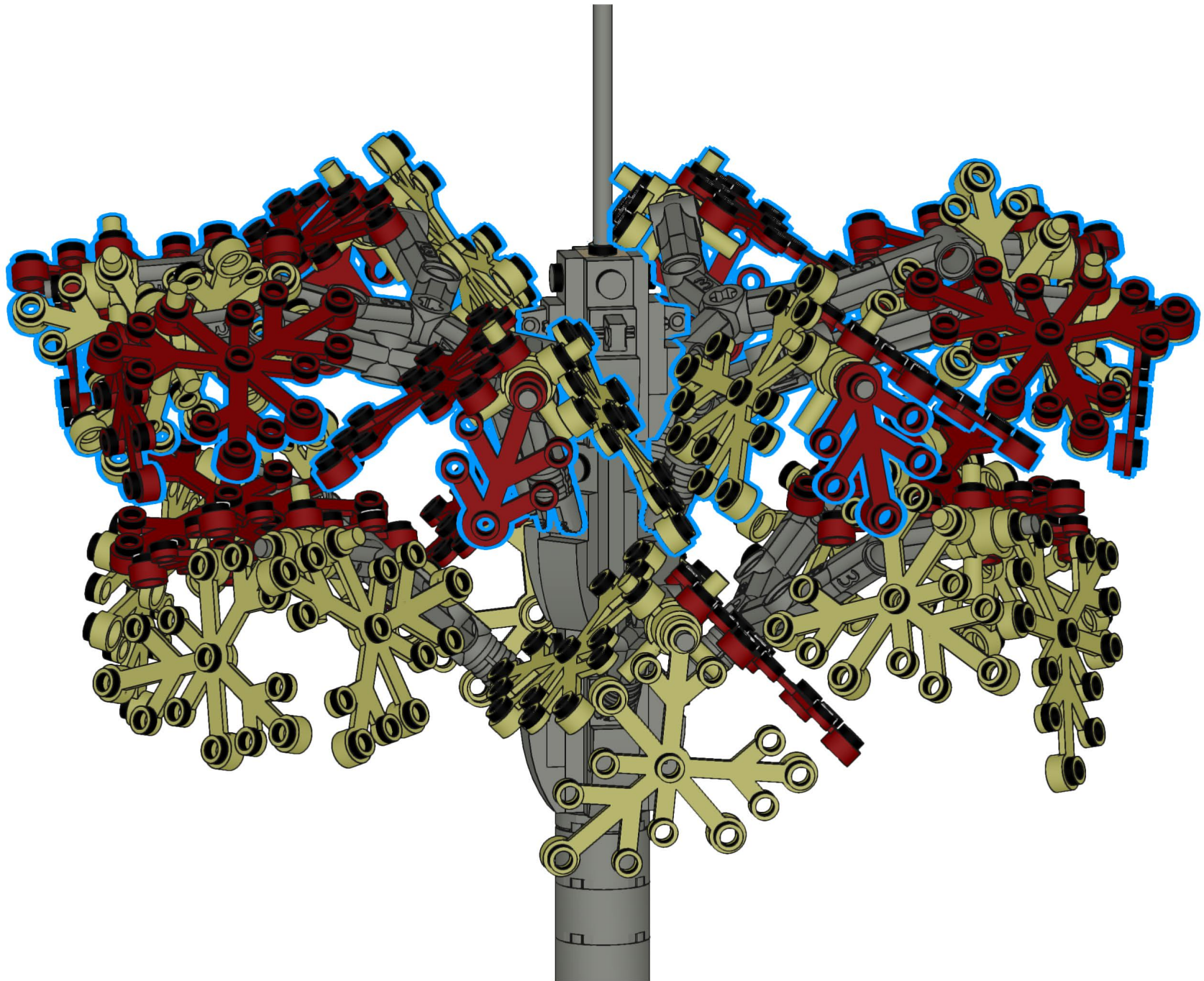



# 51



1x

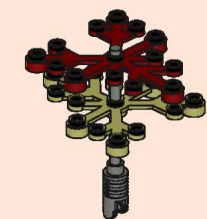

2x

# 52

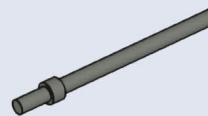

1x

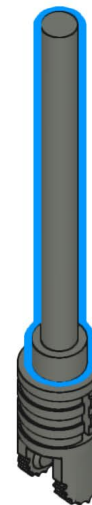

# 53



1x

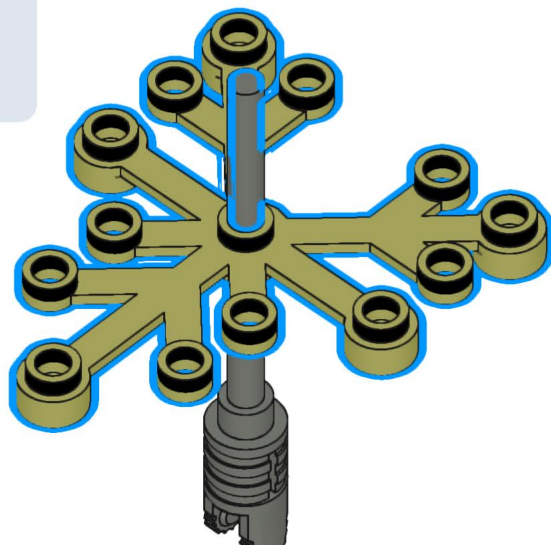

# 54



1x

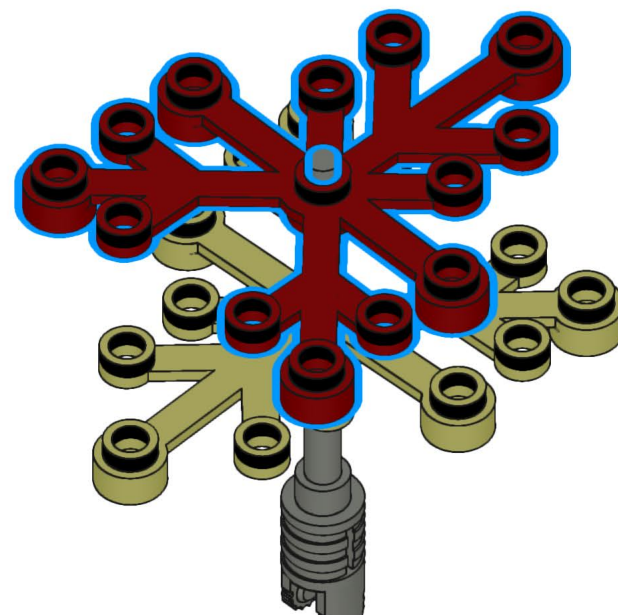

55

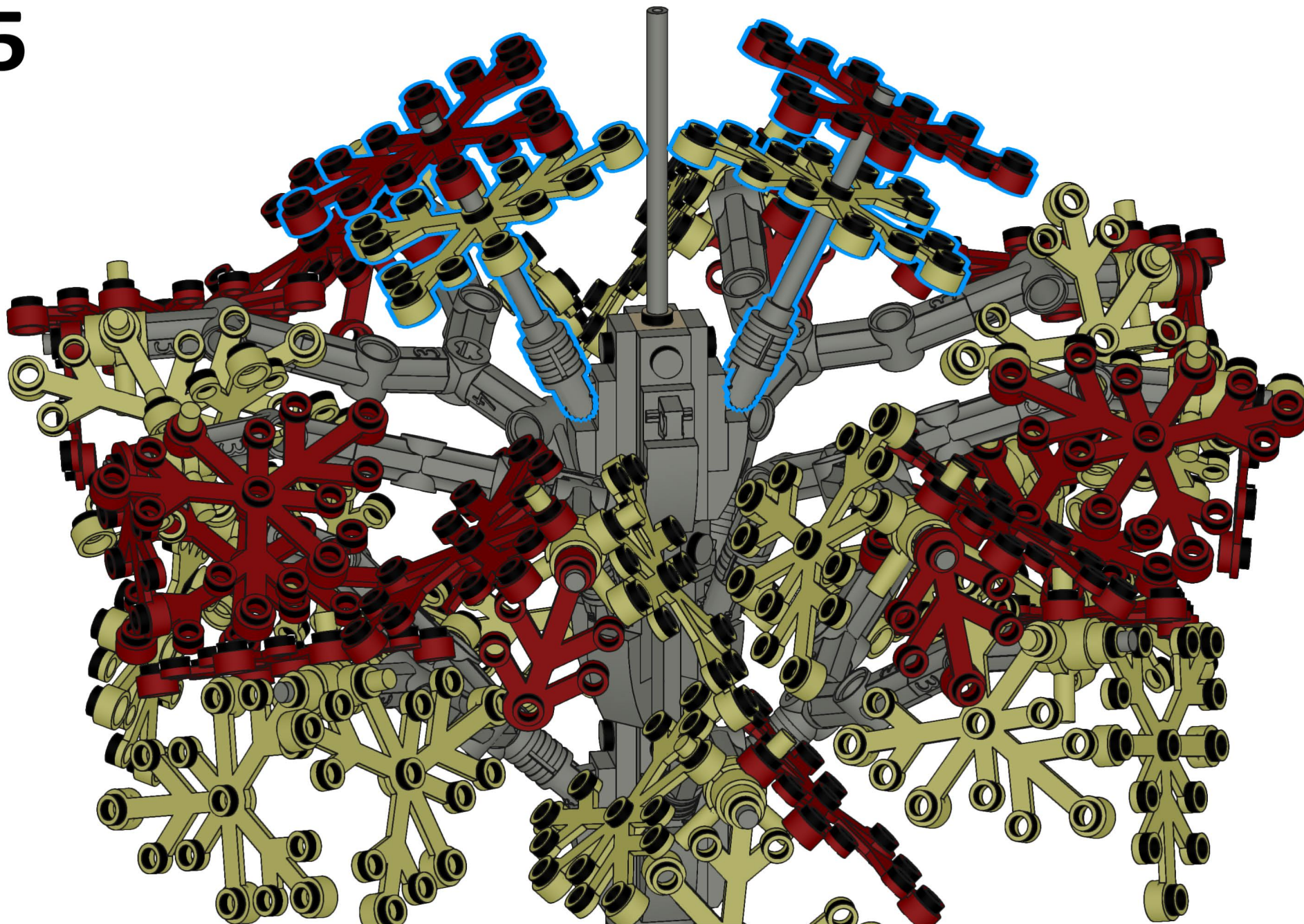

# 56



1x

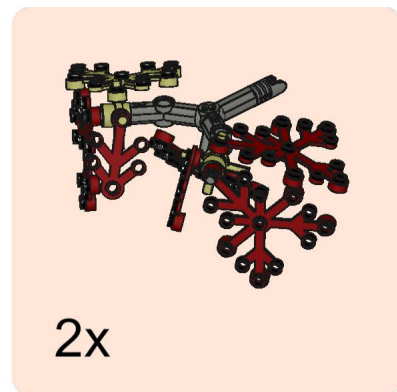

2x

# 57



1x

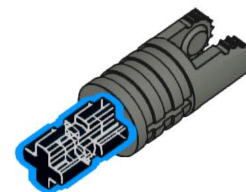

# 58



1x

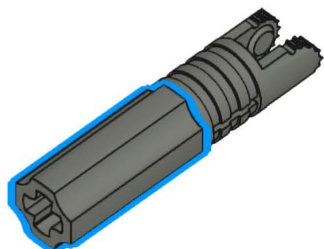

# 59



1x

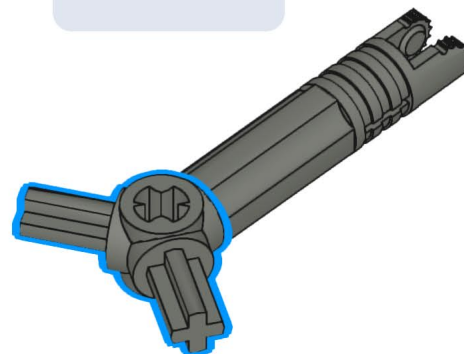

60

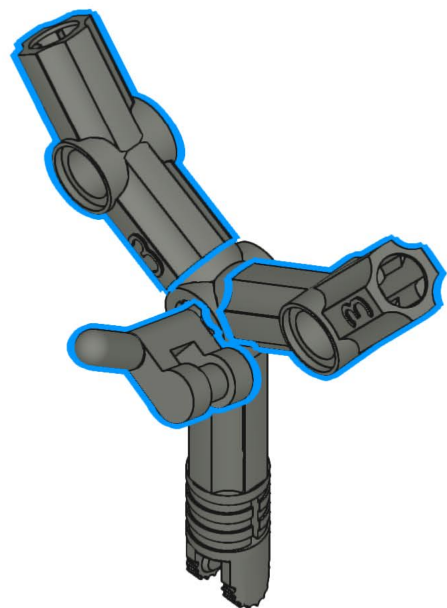
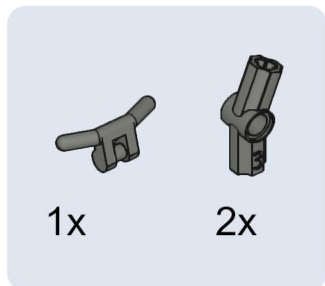

61

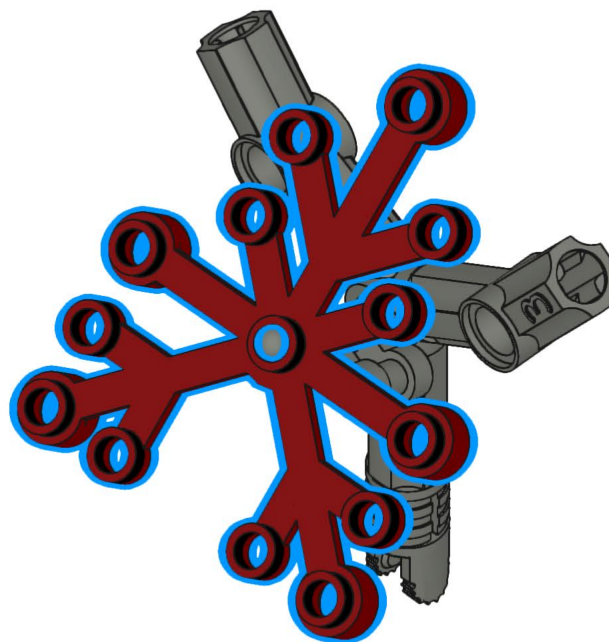
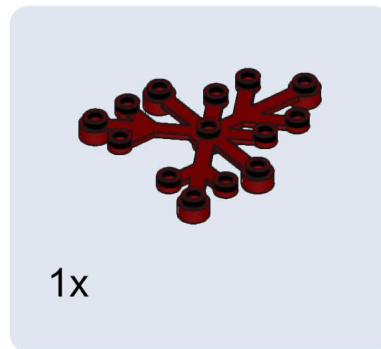

# 62

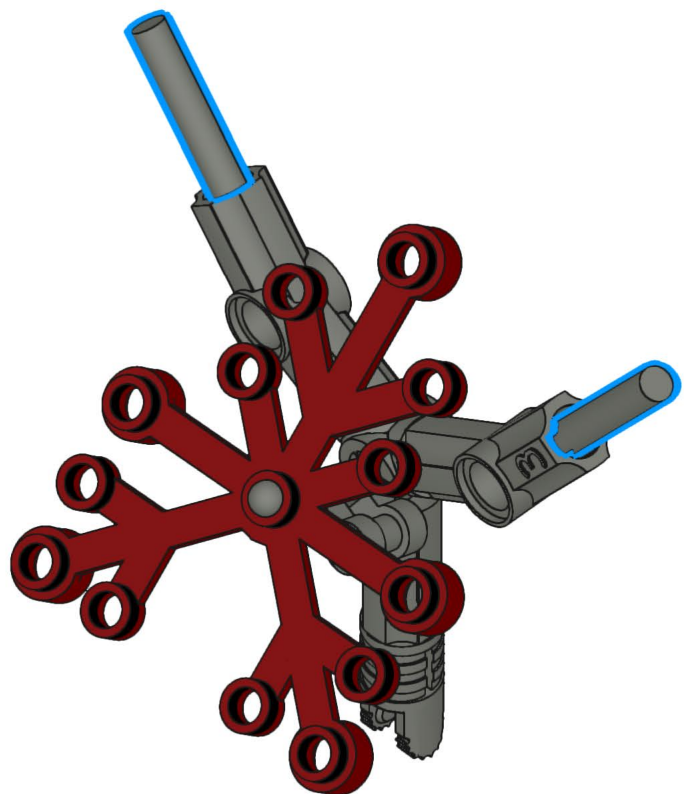
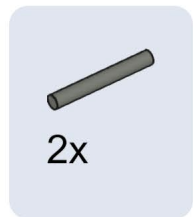

# 63

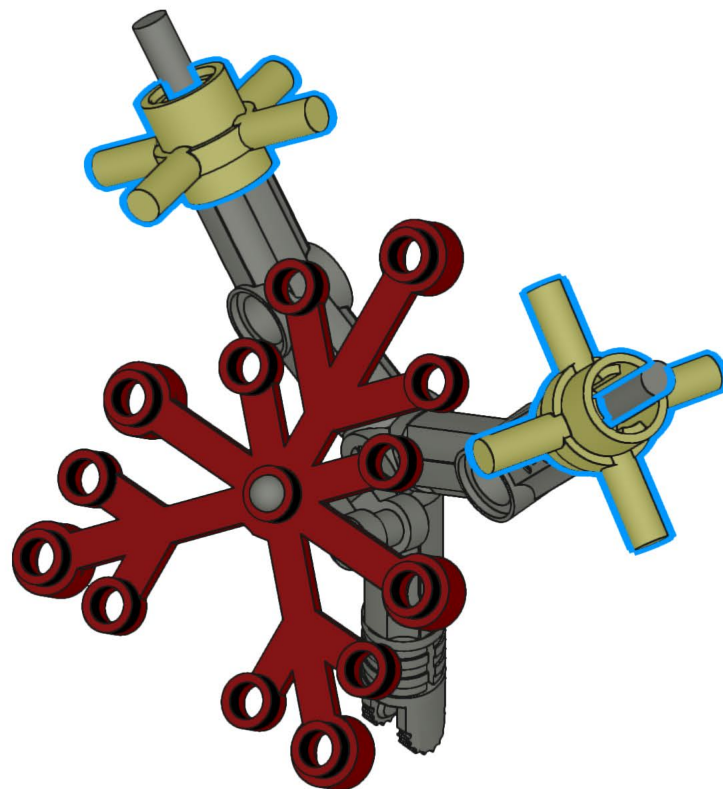
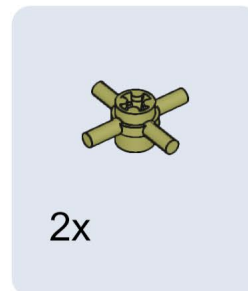

64

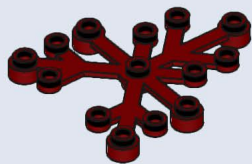

1x

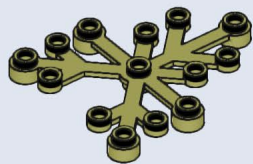

1x

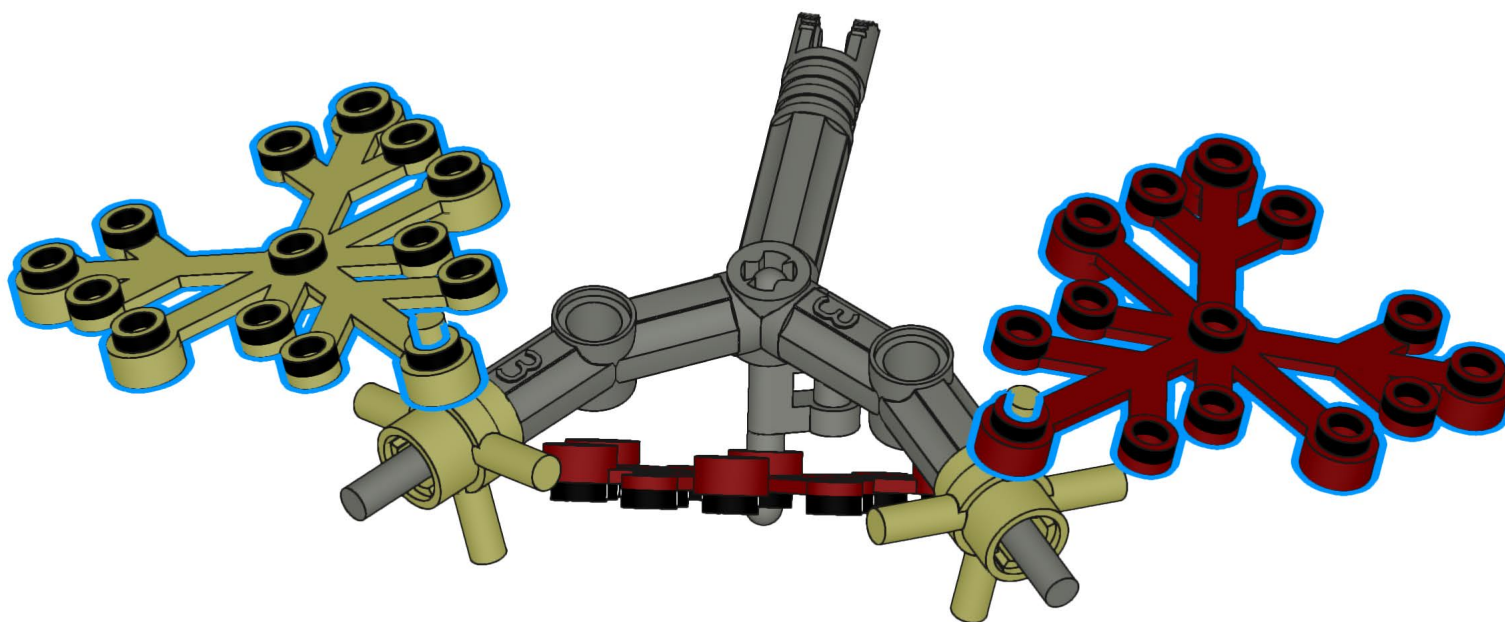

# 65

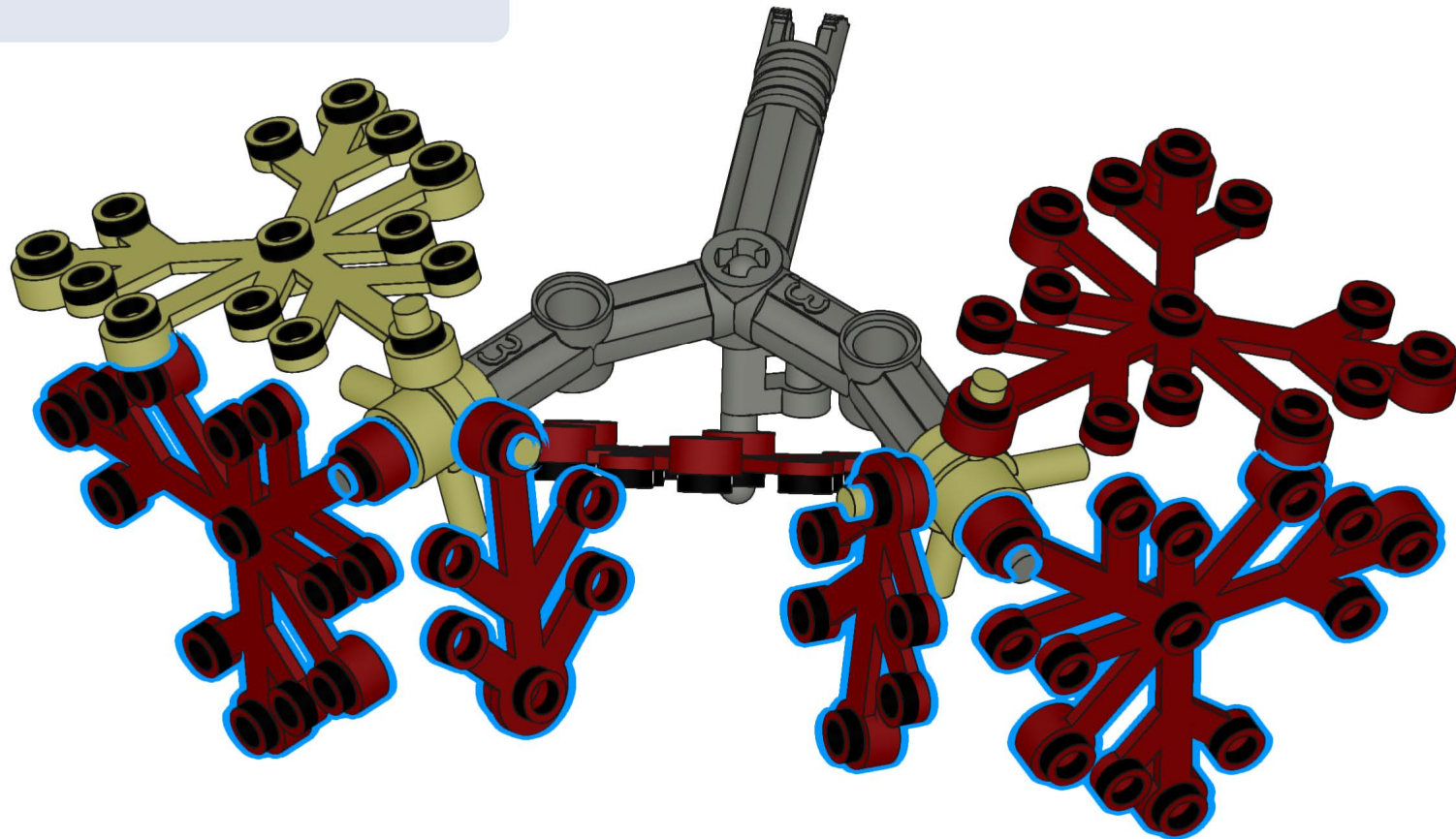
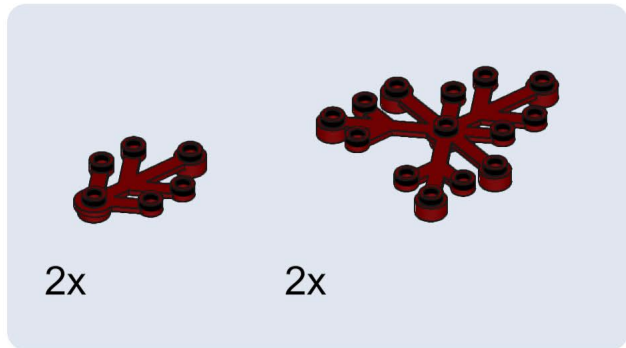

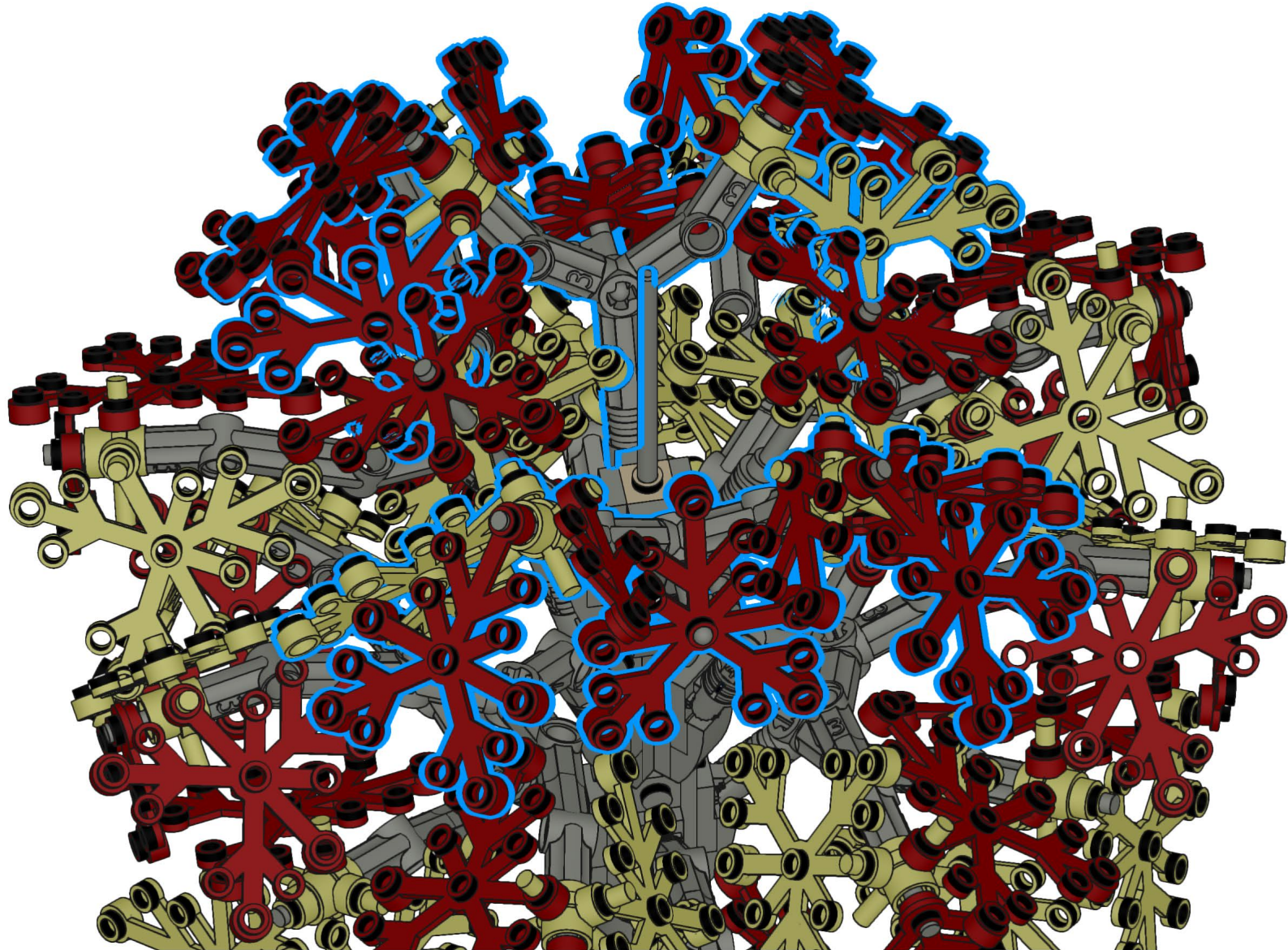



67

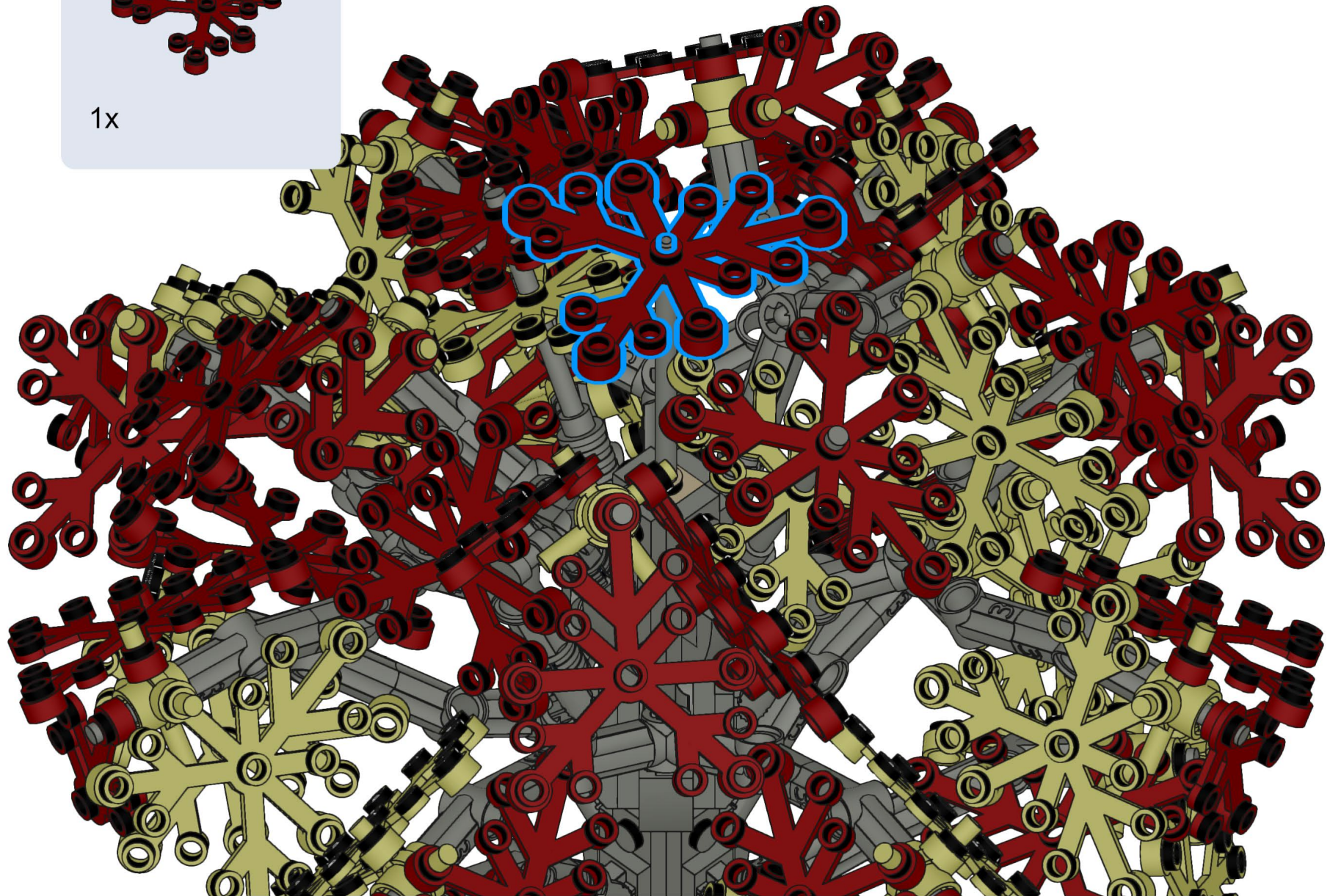
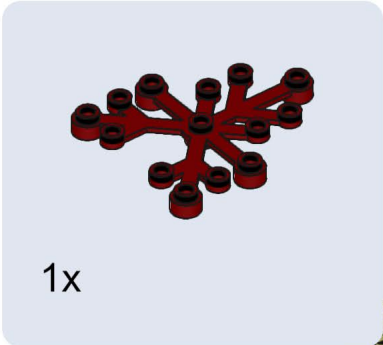

68



69





66x

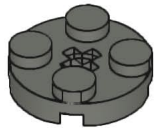

3x

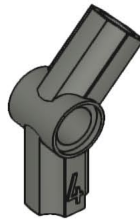

12x



36x

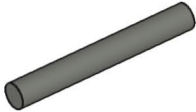

54x

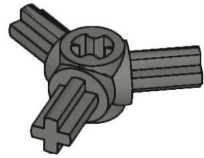

24x

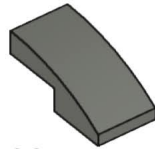

36x

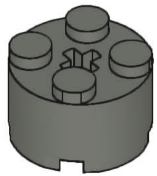

15x

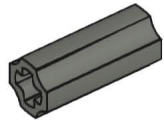

6x



6x

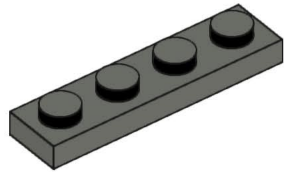

36x

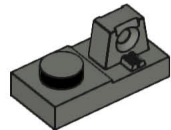

36x

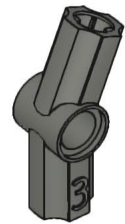

96x

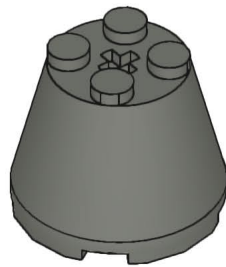

3x

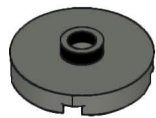

3x

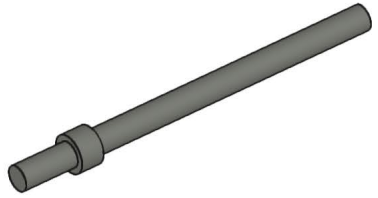

6x

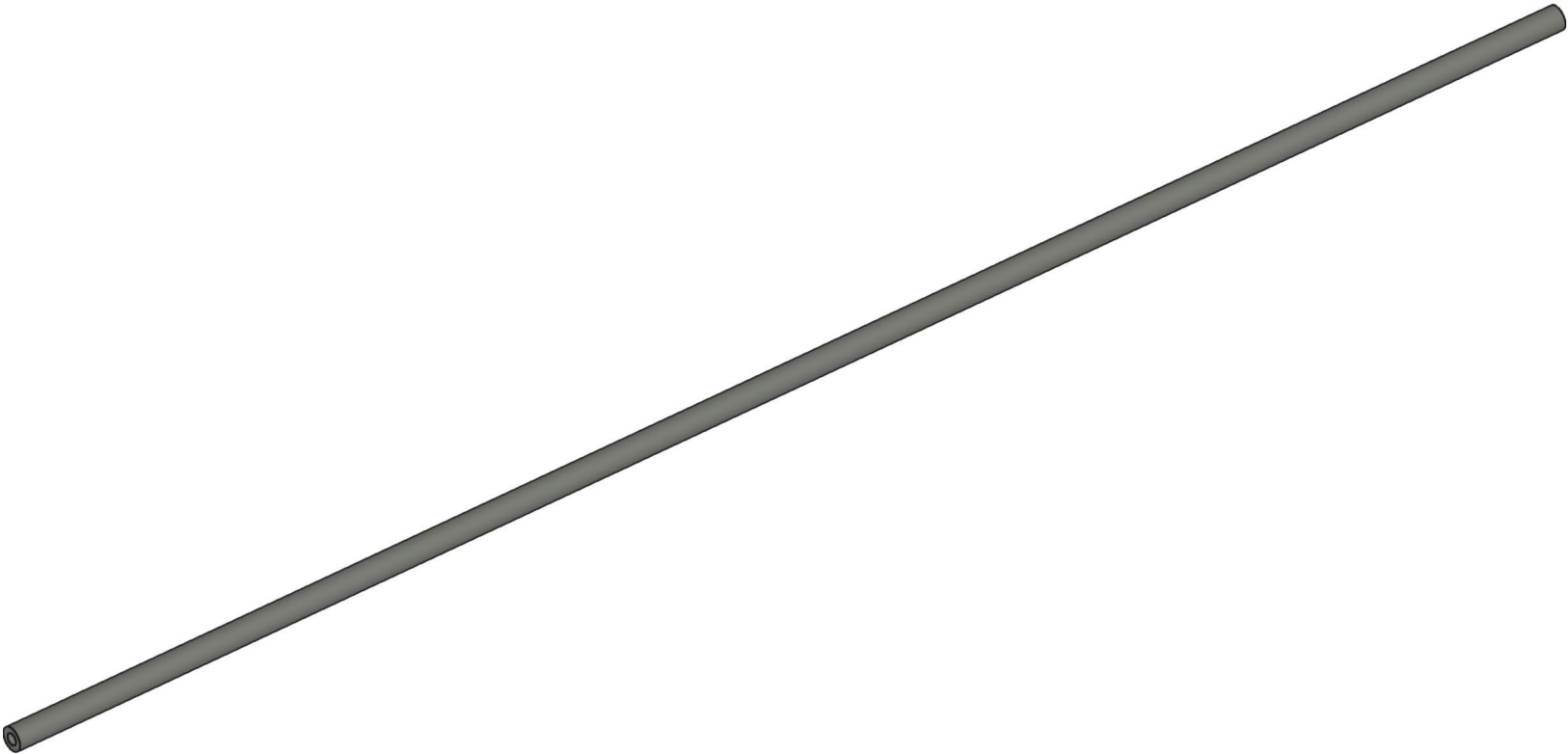

3x

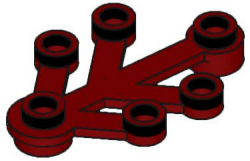

36x

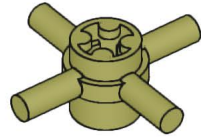

54x

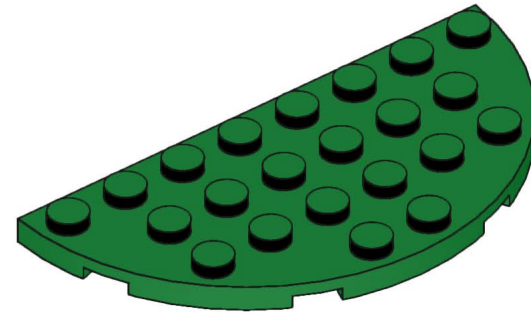

6x

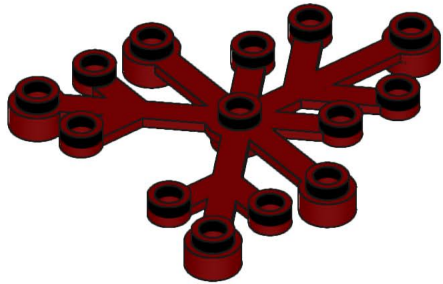

75x

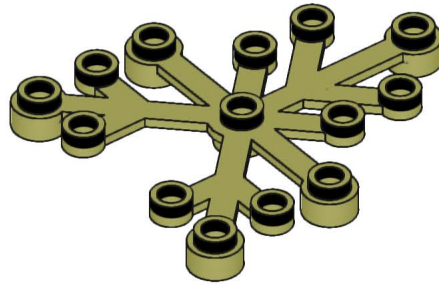

72x



12x



36x

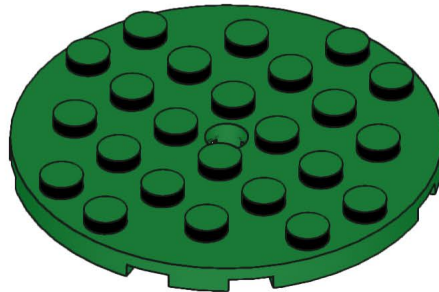

3x

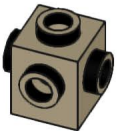

18x